

User Manual



AMAX-5070

Modbus/TCP Communication Coupler

Copyright

The documentation and the software included with this product are copyrighted 2023 by Advantech Co., Ltd. All rights are reserved. Advantech Co., Ltd. reserves the right to make improvements in the products described in this manual at any time without notice. No part of this manual may be reproduced, copied, translated or transmitted in any form or by any means without the prior written permission of Advantech Co., Ltd. Information provided in this manual is intended to be accurate and reliable. However, Advantech Co., Ltd. assumes no responsibility for its use, nor for any infringements of the rights of third parties, which may result from its use.

Acknowledgments

Intel and Pentium are trademarks of Intel Corporation.

Microsoft Windows and MS-DOS are registered trademarks of Microsoft Corp.

All other product names or trademarks are properties of their respective owners.

Product Warranty (2 years)

Advantech warrants to you, the original purchaser, that each of its products will be free from defects in materials and workmanship for two years from the date of purchase.

This warranty does not apply to any products which have been repaired or altered by persons other than repair personnel authorized by Advantech, or which have been subject to misuse, abuse, accident or improper installation. Advantech assumes no liability under the terms of this warranty as a consequence of such events.

Because of Advantech's high quality-control standards and rigorous testing, most of our customers never need to use our repair service. If an Advantech product is defective, it will be repaired or replaced at no charge during the warranty period. For out-of-warranty repairs, you will be billed according to the cost of replacement materials, service time and freight. Please consult your dealer for more details.

If you think you have a defective product, follow these steps:

1. Collect all the information about the problem encountered. (For example, CPU speed, Advantech products used, other hardware and software used, etc.) Note anything abnormal and list any onscreen messages you get when the problem occurs.
2. Call your dealer and describe the problem. Please have your manual, product, and any helpful information readily available.
3. If your product is diagnosed as defective, obtain an RMA (return merchandise authorization) number from your dealer. This allows us to process your return more quickly.
4. Carefully pack the defective product, a fully-completed Repair and Replacement Order Card and a photocopy proof of purchase date (such as your sales receipt) in a shippable container. A product returned without proof of the purchase date is not eligible for warranty service.
5. Write the RMA number visibly on the outside of the package and ship it prepaid to your dealer.

Part No. 2003507000

Printed in Taiwan

Edition 1

June 2023

Declaration of Conformity

CE

This product has passed the CE test for environmental specifications when shielded cables are used for external wiring. We recommend the use of shielded cables. This kind of cable is available from Advantech. Please contact your local supplier for ordering information.

Test conditions for passing also include the equipment being operated within an industrial enclosure. In order to protect the product from damage caused by electrostatic discharge (ESD) and EMI leakage, we strongly recommend the use of CE-compliant industrial enclosure products.

FCC Class A

This equipment has been tested and found to comply with the limits for a Class A digital device, pursuant to part 15 of the FCC Rules. These limits are designed to provide reasonable protection against harmful interference when the equipment is operated in a commercial environment. This equipment generates, uses, and can radiate radio frequency energy and, if not installed and used in accordance with the instruction manual, may cause harmful interference to radio communications. Operation of this equipment in a residential area is likely to cause harmful interference. In this event, users are required to correct the interference at their own expense.

Technical Support and Assistance

1. Visit the Advantech website at www.advantech.com/support to obtain the latest product information.
2. Contact your distributor, sales representative, or Advantech's customer service center for technical support if you need additional assistance. Please have the following information ready before you call:
 - Product name and serial number
 - Description of your peripheral attachments
 - Description of your software (operating system, version, application software, etc.)
 - A complete description of the problem
 - The exact wording of any error messages

Safety Precaution - Static Electricity

Follow these simple precautions to protect yourself from harm and the products from damage.

- To avoid electrical shock, always disconnect the power from your PC chassis before you work on it. Don't touch any components on the CPU card or other cards while the PC is on.
- Disconnect power before making any configuration changes. The sudden rush of power as you connect a jumper or install a card may damage sensitive electronic components.

Safety Instructions

1. Install the system only in area with restricted access.
2. Read these safety instructions carefully.
3. Retain this user manual for future reference.
4. Disconnect the equipment from all power outlets before cleaning. Use only a damp cloth for cleaning. Do not use liquid or spray detergents.
5. For pluggable equipment, the power outlet socket must be located near the equipment and easily accessible.
6. Protect the equipment from humidity.
7. Place the equipment on a reliable surface during installation. Dropping or letting the equipment fall may cause damage.
8. The openings on the enclosure are for air convection. Protect the equipment from overheating. Do not cover the openings.
9. Ensure that the voltage of the power source is correct before connecting the equipment to a power outlet.
10. Position the power cord away from high-traffic areas. Do not place anything over the power cord.
11. All cautions and warnings on the equipment should be noted.
12. If the equipment is not used for a long time, disconnect it from the power source to avoid damage from transient overvoltage.
13. Never pour any liquid into an opening. This may cause fire or electrical shock.
14. Never open the equipment. For safety reasons, the equipment should be opened only by qualified service personnel.
15. If any of the following occurs, have the equipment checked by service personnel:
 - The power cord or plug is damaged.
 - Liquid has penetrated the equipment.
 - The equipment has been exposed to moisture.
 - The equipment is malfunctioning, or does not operate according to the user manual.
 - The equipment has been dropped and damaged.
 - The equipment shows obvious signs of breakage.
16. Do not leave the equipment in an environment with a storage temperature of below $-20\text{ }^{\circ}\text{C}$ ($-4\text{ }^{\circ}\text{F}$) or above $60\text{ }^{\circ}\text{C}$ ($140\text{ }^{\circ}\text{F}$) as this may damage the components. The equipment should be kept in a controlled environment.
17. **CAUTION:** Batteries are at risk of exploding if incorrectly replaced. Replace only with the same or equivalent type as recommended by the manufacturer. Discard used batteries according to the manufacturer's instructions.
18. In accordance with IEC 704-1:1982 specifications, the sound pressure level at the operator's position does not exceed 70 dB (A).

DISCLAIMER: These instructions are provided according to IEC 704-1 standards. Advantech disclaims all responsibility for the accuracy of any statements contained herein.

Contents

Chapter 1	Introduction.....	1
1.1	Introduction	2
1.2	Hardware System Diagram	2
	Figure 1.1 AMAX-5070 Hardware System Diagram	2
	Figure 1.2 AMAX-5070 Cable Redundancy Hardware System Diagram in Tree Topology	3
	Figure 1.3 AMAX-5070 Cable Redundancy Hardware System Diagram in Ring Topology	4
1.2.1	Power Application and Consumption	5
	Figure 1.4 Power Module Application Diagram	5
	Table 1.1: Coupler and Power Module Rated Voltage and Mac Current.....	5
	Table 1.2: SubDevice Power Consumption.....	5
1.2.2	Hardware Installation and information	5
1.2.3	AMAX-5070 Support SubDevices List	5
Chapter 2	AMAX-5070 Modbus/TCP Coupler with ID Switch7	
2.1	AMAX-5070 Specification	8
	Figure 2.1 AMAX-5070 Module	8
2.1.1	General	9
2.1.2	Power Input.....	9
2.1.3	Modbus/TCP Coupler	9
2.1.4	Environment.....	9
2.1.5	Reliability Test.....	9
2.2	LED Indicator	10
	Figure 2.2 AMAX-5070 Module LED Indicator.....	10
	Table 2.1: AMAX-5070 Module LED Indicator.....	10
2.3	ID Switch	11
	Figure 2.3 AMAX-5070 ID Switch	11
	Table 2.2: AMAX-5070 ID Switch	11
2.4	Pin Definition	12
	Figure 2.4 AMAX-5070 Module Front View	12
	Figure 2.5 AMAX-5070 Module Side View	12
	Table 2.3: Upper 4-Pin Connector.....	13
	Table 2.4: Lower 2 LAN Port	13
2.5	Application Wiring	13
	Figure 2.6 Wiring for AMAX-5070 Power Input.....	13
2.6	Dimensions	14
	Figure 2.7 AMAX-5070 Dimensions	14
2.7	AMAX-5070 Object Dictionary	14
	Table 2.5: Input Data (4x9901 - 4x9913).....	14
Chapter 3	System Configuration	17
3.1	Connect and Search Modules.....	18
3.1.1	Searching for the Coupler	18
	Figure 3.1 Searching for AMAX-5070.....	18
	Figure 3.2 : AMAX-5070 in Different Network.....	19
3.1.2	Searching for the EtherCAT SubDevice	20
	Figure 3.3 : The Subdevice Condition and Topology.....	20

	Figure 3.4 Group ID Conflict.....	21
3.2	Module Information	21
	Figure 3.5 Coupler Configuration Page.....	21
	Figure 3.6 Different Subnet Mask Error.....	22
	Figure 3.7 Re-setting the AMAX-5070 IP Address	23
	Figure 3.8 Coupler Configuration in Different Internet Segment.....	23
3.2.1	Main Node Information page (Coupler)	24
	Figure 3.9 Coupler Information Page	24
3.2.2	Subordinate Node Information page (SubDevice).....	24
	Figure 3.10SubDevice Information Page.....	24
3.2.3	SubDevice Support List	25
	Figure 3.11Support SubDevice List.....	25
3.3	Module Setting	25
3.3.1	Network Configuration	25
	Figure 3.12Network Configuration Page	25
3.3.2	AMAX-5070 Switch ID	26
	Figure 3.13AMAX-5070 Switch ID.....	26
3.3.3	Rescan the SubDevice and Topology	26
	Figure 3.14Rescan Function	26
	Figure 3.15Time out	27
3.3.4	Restart the OS of the AMAX-5070.....	27
	Figure 3.16Restart the System.....	27
3.3.5	Cable Redundancy Configuration.....	28
	Figure 3.17Cable Redundancy Setting.....	28
	Figure 3.18Cable Redundancy Notification for Wiring.....	28
	Figure 3.19Cable Redundancy Notification for Estimated Reset Time	29
3.3.6	Obtaining the Topology Status	29
	Figure 3.20Topology Status	30
3.4	Modbus Address Setting.....	31
	Figure 3.21AMAX-5070 Modbus Client Address and Rotary Switch 31	
	Table 3.1: AMAX-5074 Group ID and Modbus Client Device ID31	
	Figure 3.22System Topology with Group ID and Device ID	32
	Figure 3.23Modbus Address in Different Group ID and User Mode 32	
3.4.1	Modbus Addresses for Connected Modules (Fixed Mode).....	33
	Figure 3.24Modbus Address Setting Page.....	33
	Figure 3.25Modbus Address	33
3.4.2	Export the List of Modbus TCP Addresses for All Modules	34
	Figure 3.26Export the ModBus TCP Address in Fixed Mode	34
	Figure 3.27Modbus TCP Addresses and Modules List in CSV File (Fixed Mode)	34
3.4.3	Modbus Addresses for Connected Modules (Flexible Mode).....	35
	Figure 3.28Flexible Mode	35
	Figure 3.29Modbus Coil Status and Holding Register.....	36
	Figure 3.30Flexible Mode Mapping Topology Status	36
	Figure 3.31Check the Unmatched SubDevices.....	37
3.4.4	Export the List of Modbus TCP Addresses for All Modules (Flexible Mode).....	37
	Figure 3.32Export the ModBus TCP Address in Flexible Mode .	37
	Figure 3.33Modbus TCP Addresses and Modules List in CSV File (Flexible Mode).....	38
3.4.5	Identify the Modules of Abnormal Communication	38
	Figure 3.34Mark Communication Status	38
	Figure 3.35Mark Communication Status when Module disconnec- tion.....	39

Chapter 4 Coupler and SubDevice Configuration

41

4.1	Coupler and SubDevice Configuration	42
4.1.1	Device Categories.....	42
	Figure 4.1 Device Categories	42
	Figure 4.2 Coupler or Coordinator Module Information	43
	Figure 4.3 SubDevice Information	43
	Figure 4.4 Unknown Module Information	44
4.1.2	Storing and Loading Configurations.....	44
	Figure 4.5 Save and Load Configuration	44
	Figure 4.6 DI/DO Configuration	45
	Figure 4.7 Example of Not Supported SubDevice UI	45
4.1.3	Locate SubDevices	46
	Figure 4.8 Locating SubDevice Function.....	46
	Figure 4.9 SubDevice without LED Locate Function	46
4.2	Obtain and Configure Coupler and SubDevice	47
4.2.1	Obtain Power SubDevices Status.....	47
	Figure 4.10Power Status	47
	Figure 4.11Power Status and Modbus Address Information	47
4.2.2	Analogue Input SubDevices.....	48
	Figure 4.12Analogue Input Status	48
	Figure 4.13Analogue Input Value and Modbus Address Information.....	49
	Figure 4.14Expand the Tree and Change the AMAX-5018 Range	49
	Figure 4.15Apply the Change for All Channels of This SubDevice	50
4.2.3	Analogue Output SubDevices.....	50
	Figure 4.16Analogue Output Status	50
	Figure 4.17Analogue Output Value and Modbus Address Information.....	51
	Figure 4.18 Expand the Tree and Change the AMAX-5024 Range	51
4.2.4	Digital Input SubDevices.....	52
	Figure 4.19Digital Input Status	52
	Figure 4.20Digital Input Value and Modbus Address Information	52
	Figure 4.21Enable AMAX-5060 Digital Filter	53
4.2.5	Digital Output SubDevices	54
	Figure 4.22Digital Output Status.....	54
	Figure 4.23Digital Output Value and Modbus Address Information	54
	Figure 4.24Change AMAX-5060 Digital Output Status.....	55
	Figure 4.25Configure AMAX-5060 Safety Value	56
	Figure 4.26AMAX-5060 Safety Setting.....	56
4.2.6	Counter/Encoder SubDevices.....	57
	Figure 4.27Counter and Encoder Status	57
	Figure 4.28Counter/Encoder and Modbus Address Information	57
	Figure 4.29Change AMAX-5080 CNT Mode	58
	Figure 4.30Enable the Latch Counter.....	59

Chapter 5 Utility Management Tool61

5.1	Favorite Group Function	62
	Figure 5.1 Add New Favorite Group	62
	Figure 5.2 Create New Group.....	62
	Figure 5.3 Add New Device for Favorite Group.....	62
	Figure 5.4 Configure the Ethernet Device	63
	Figure 5.5 New Device Has Been Added Under Newgroup	64

	Figure 5.6 Connect Status is GOOD	64
	Figure 5.7 Connect Status is CorrespondingFail.....	65
	Figure 5.8 Configure the Modules in Favorite Group	65
5.2	Terminal for Command Testing Function.....	66
	Figure 5.9 Entire the Terminal for Command Testing	66
	Figure 5.10Connect to AMAX-5070 via Terminal for Command Testing.....	67
	Figure 5.11Modbus Information in Terminal for Command Testing 67	
	Figure 5.12ASCII command in Terminal for Command Testing.	68

Chapter 1

Introduction

1.1 Introduction

In order to enhance the experience of AMAX-5070, please download the below manual and software from Advantech office website:

AMAX-5000 Series I/O Modules User Manual

Advantech I/O Module Utility

This manual will only introduce AMAX-5070 Modbus/TCP Coupler. To know more about the AMAX-5000 series I/O modules, please download AMAX-5000 Series I/O user manual from our official website.

1.2 Hardware System Diagram

For the example demonstration showing how to use AMAX-5070, the system hardware architecture can be shown as Figure 1.1. LAN port 1 and 2 can be connected by MainDevice(MDevice) via Modbus/TCP but also LAN port 2 provide cable redundancy via EtherCAT. The cable redundancy system diagram in tree topology please refer to the Figure 1.2 and the ring topology refer to the Figure 1.3.

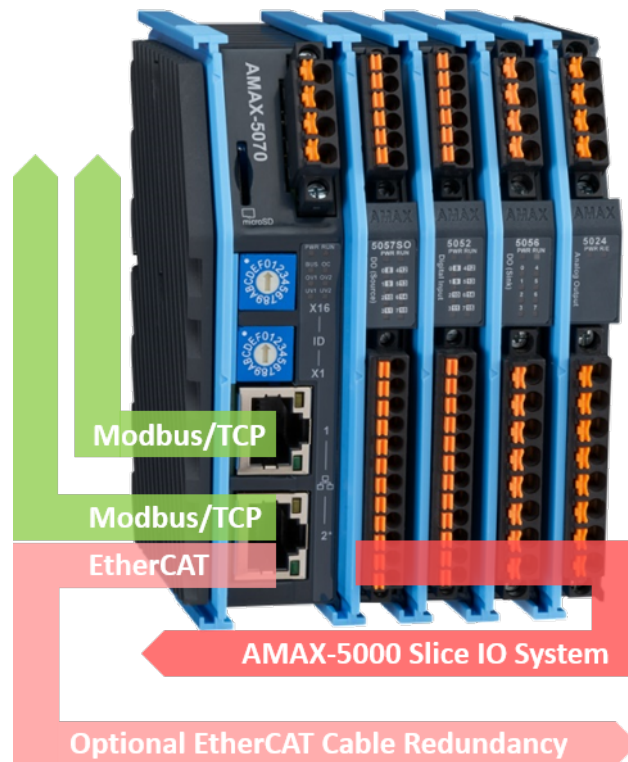

Figure 1.1 AMAX-5070 Hardware System Diagram

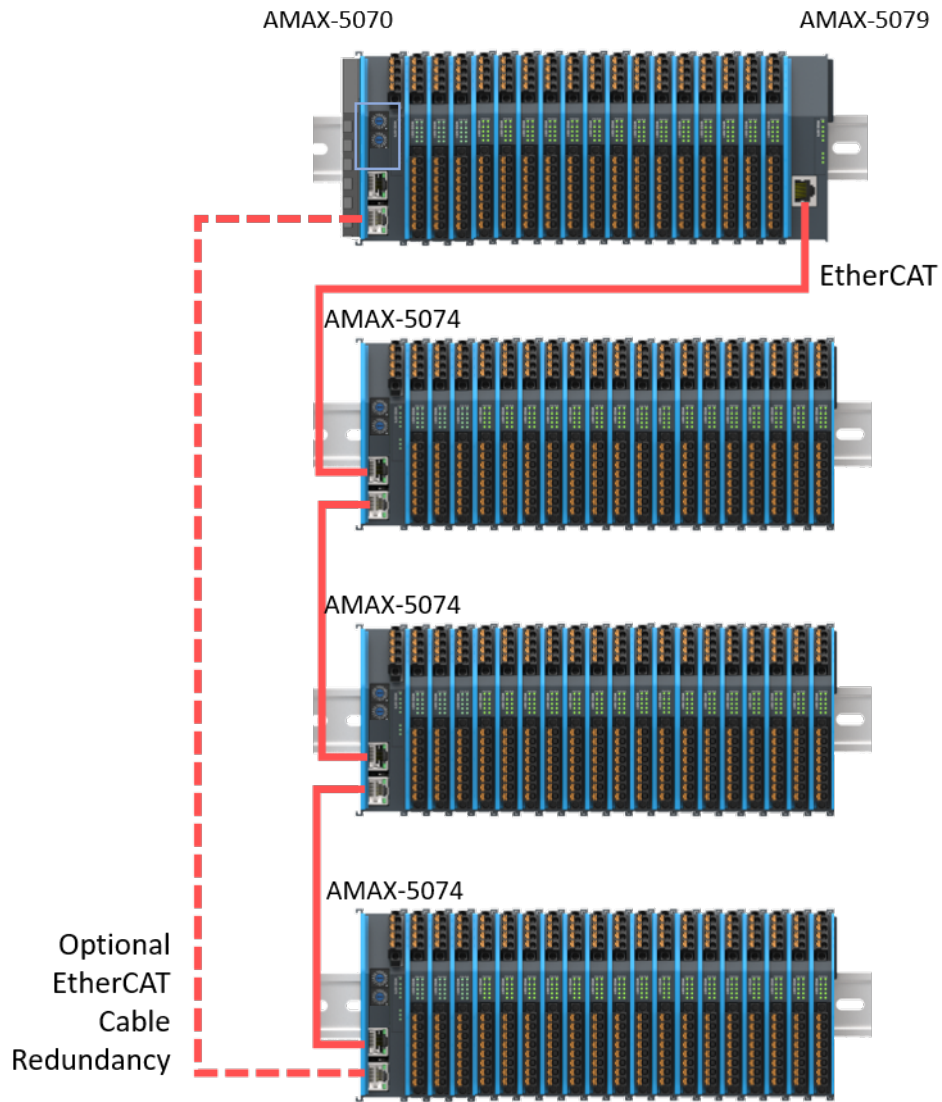

Figure 1.2 AMAX-5070 Cable Redundancy Hardware System Diagram in Tree Topology

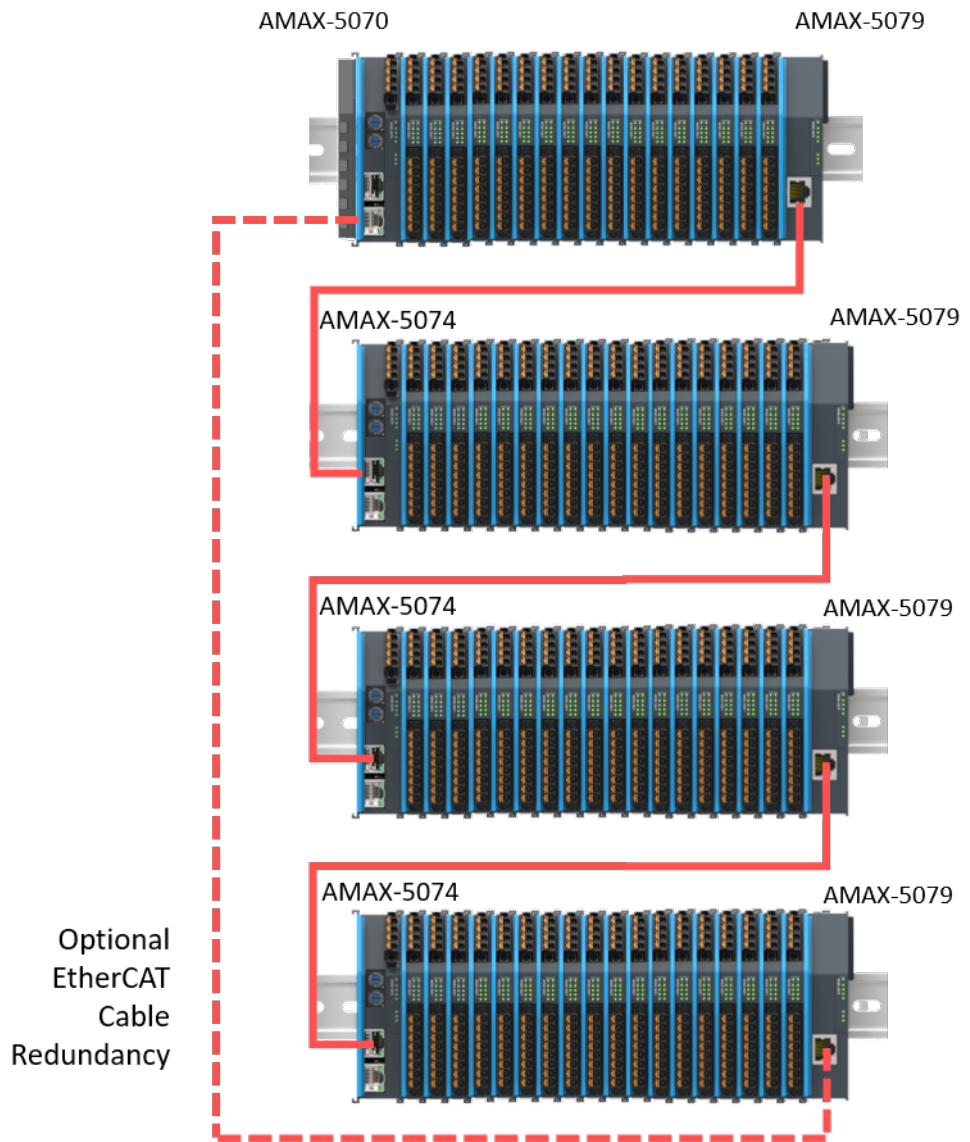

Figure 1.3 AMAX-5070 Cable Redundancy Hardware System Diagram in Ring Topology

1.2.1 Power Application and Consumption

The AMAX-5070 provide maximum 2A current for the following SubDevices. Inserting AMAX-5001 between I/O modules if user demand to apply more SubDevices (Figure 1.4). For the power modules and SubDevices power consumption please refer to the Table 1.1 and Table 1.2.

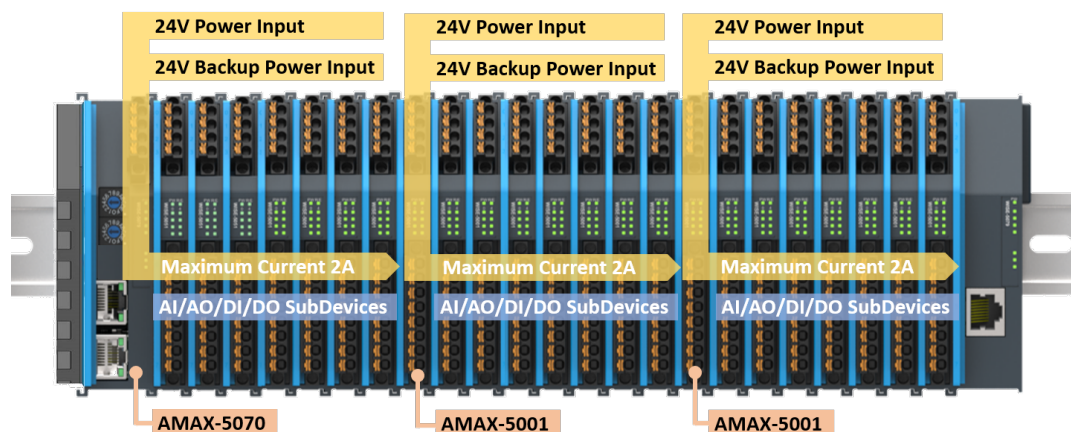

Figure 1.4 Power Module Application Diagram

Table 1.1: Coupler and Power Module Rated Voltage and Mac Current		
Module Name	Rated Voltage (VDC)	Maximum Current (A)
AMAX-5001	24 ($\pm 20\%$)	2
AMAX-5070	24 ($\pm 20\%$)	2
AMAX-5074	24 ($\pm 20\%$)	2

Table 1.2: SubDevice Power Consumption	
Module Name	Power Consumption (W)
AMAX-5079	N/A
Other AMAX-5000 Series SubDevices	Approx. 3 ^[1]

[1]: For each module's precious power consumption, please refer to the **AMAX-5000 Series I/O User Manual**.

1.2.2 Hardware Installation and information

For the AMAX-5070 and AMAX-5000 Series I/O modules' Hardware permissible installation positions, Wiring, Cable Length, Cable Selection, RJ45 Selection, and Electromagnetic Protection. Please refer to the **AMAX-5000 Series User Manual**.

1.2.3 AMAX-5070 Support SubDevices List

The supporting SubDevices for AMAX-5070, please download Advantech I/O Module Utility from AMAX-5070 website and following this chapter **Subordinate Node Information page (SubDevice)**.

Chapter 2

AMAX-5070 Modbus/
TCP Coupler with ID
Switch

2.1 AMAX-5070 Specification

AMAX-5070 is a coupler for AMAX-5000 slice IO system. It is a compact and flexible Modbus/TCP IO System. AMAX-5000 series IO modules have some common design features to help customers shorter their engineering time. This includes push-in wiring terminal / front LED for diagnosis / slide-in installation on DIN rail as well as a bus power monitoring mechanism.



Figure 2.1 AMAX-5070 Module

2.1.1 General

- **Certification:** CE, FCC class A
- **Connector:** Pluggable 4P push-in terminal (#24~16 AWG) and 2x RJ45
- **Module Enclosure:** Polycarbonate + Aluminum Alloy
- **Protocol:** Modbus TCP
- **Transmission Rate:** 100Mbps
- **LED Indicator:** PWR, RUN, Power Diagnosis LED
- **Weight:** Approx. 190g

2.1.2 Power Input

- **Rated Voltage:** 24VDC ($\pm 20\%$)
- **Dual Power Input:** Supported
- **Max Current on Bus:** 2A
- **Diagnosis Function:**
 - Over/under voltage for input 1&2
 - Over current output on bus

2.1.3 Modbus/TCP Coupler

- **Function:** Coupling AMAX-5000 EtherCAT IO Module to Modbus/TCP network
- **Cable:** Ethernet/EtherCAT cable (min. Cat. 5), shielded
- **Distance between stations:** Max. 100 m (100BASE-TX)
- **Interface:** 2 x RJ45,
 - LAN1: Modbus/TCP,
 - LAN2: Modbus/TCP (default) or EtherCAT Cable Redundancy
- **TCP Connection No.:** 16
- **Response Time:** 5ms
- **IO Configuration:** Advantech I/O Module Utility
- **Maximum IO Modules:** 256 (excluding AMAX-5079)
- **Group ID Support:** 0~255 (maximum 20 groups)

2.1.4 Environment

- **Operation Temperature:** -25~60°C (vertical mounted)
- **Storage Temperature:** -40~85°C
- **Relative Humidity:** 95% (non-condensing)
- **Storage Humidity:** 95% (non-condensing)

2.1.5 Reliability Test

- **High Temperature Test:** IEC 68-2-78
- **Low Temperature Test:** IEC 68-2-2
- **Random Vibration Test:** IEC 68-2-64
- **Shock Test:** IEC 68-2-27
- **Package Drop Test:** Federal Standard

2.2 LED Indicator



Figure 2.2 AMAX-5070 Module LED Indicator

Table 2.1: AMAX-5070 Module LED Indicator			
LED	Color	Indication	Behavior
PWR	Green	On	Power On
	Orange	On	Locating Module
RUN	Green	On	EtherCAT Connected
		Blinking	EtherCAT Connecting
BUS	Green	On	Bus Power On
OC	RED	On	Bus Over Current (2A)
OV1	RED	On	V1 Over-voltage (28.8V)
OV2	RED	On	V2 Over-voltage (28.8V)
UV1	RED	On	V1 Under-voltage (19.2V)
UV2	RED	On	V2 Under-voltage (19.2V)

2.3 ID Switch

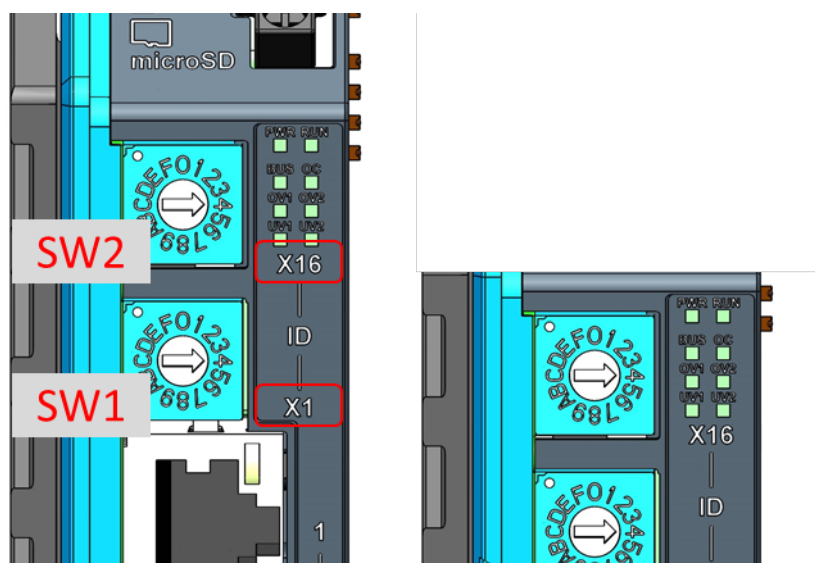

Figure 2.3 AMAX-5070 ID Switch

Table 2.2: AMAX-5070 ID Switch		
Switch Number (Top to Bottom)	Multiple	Range (HEX)
SW2	x16	0 ~ F
SW1	x1	0 ~ F
Example	(SW2, SW1) = (4, C), then ID = 4x16 + 12x1 = 76	

2.4 Pin Definition

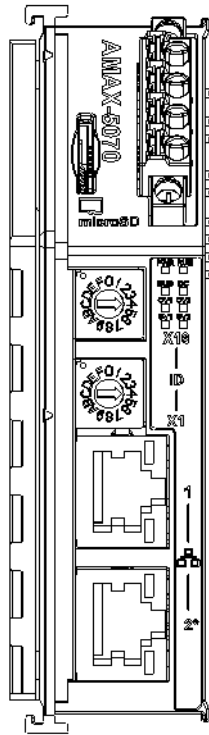

Figure 2.4 AMAX-5070 Module Front View

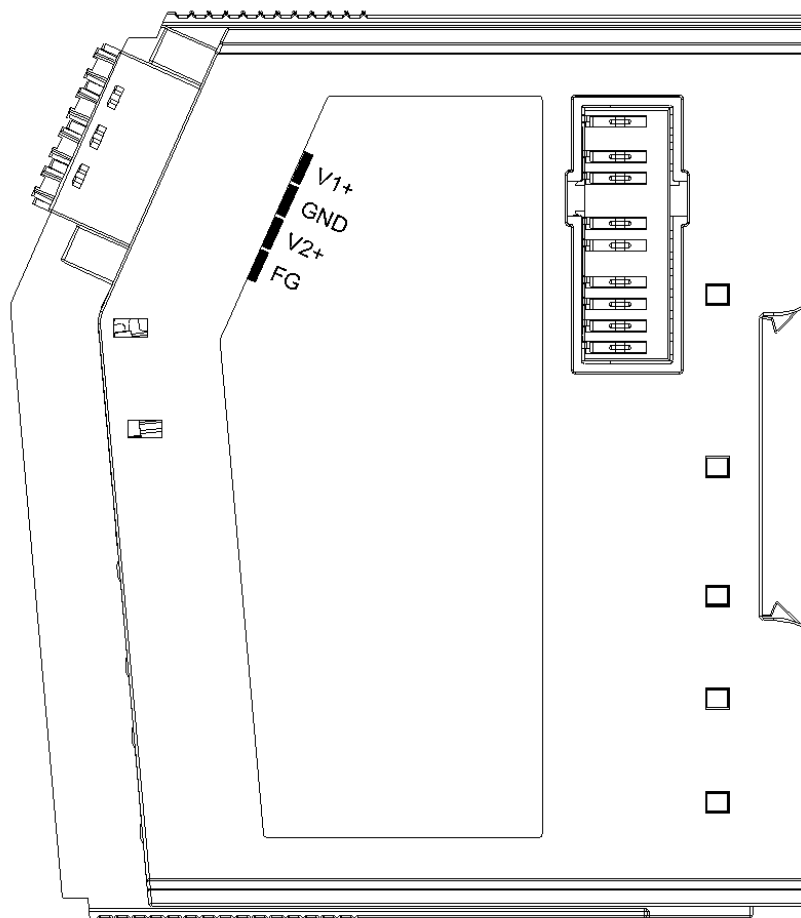

Figure 2.5 AMAX-5070 Module Side View

Table 2.3: Upper 4-Pin Connector	
Pin Number (Top to Bottom)	Pin Definition
1	V1+
2	GND
3	V2+
4	FG

Table 2.4: Lower 2 LAN Port	
LAN Number (Top to Bottom)	Port Definition
1	Modbus/TCP signal input
2	Modbus/TCP signal input or EtherCAT cable redundancy

2.5 Application Wiring

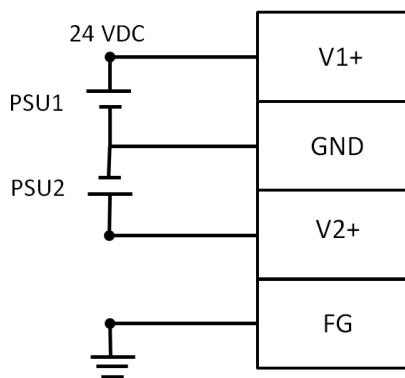

Figure 2.6 Wiring for AMAX-5070 Power Input

2.6 Dimensions

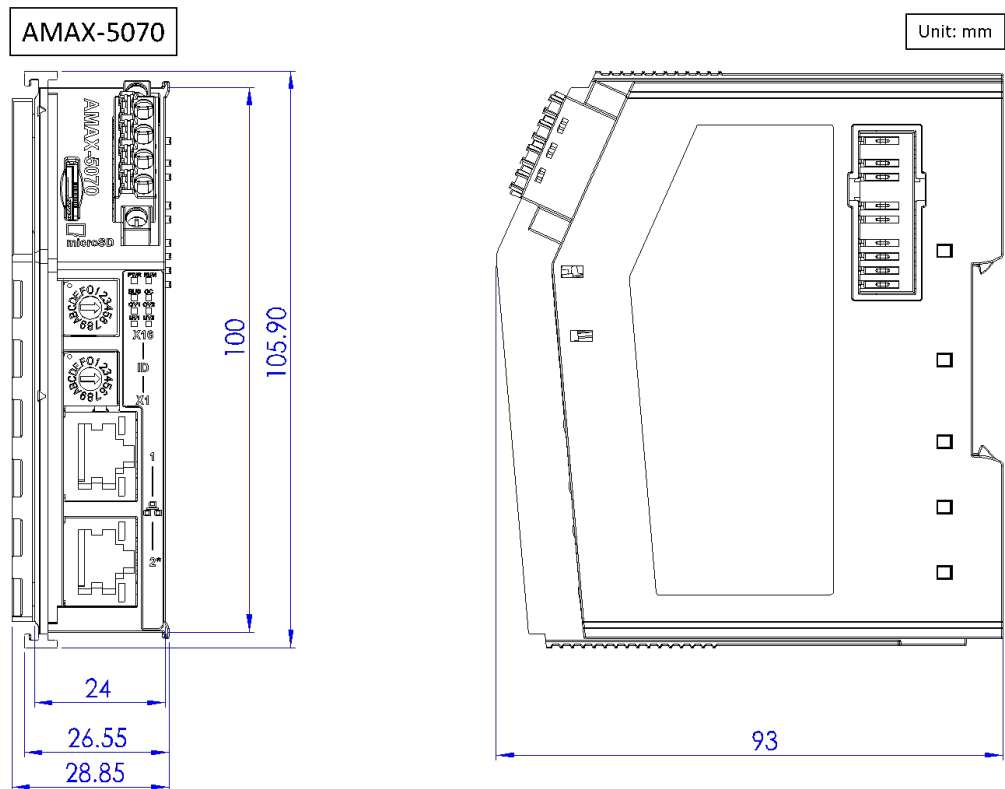

Figure 2.7 AMAX-5070 Dimensions

2.7 AMAX-5070 Object Dictionary

Table 2.5: Input Data (4x9901 - 4x9913)					
Index (hex)	Name	Meaning	Data type	Flags	Default value
4x9901	Over_Voltage_1	Voltage 1 > 28.8V (24V*1.2) [1]	UINT	RO	0x0000
4x9902	Under_Voltage_1	Voltage 1 < 19.2V (24V*0.8) [1]	UINT	RO	0x0000
4x9903	Over_Voltage_2	Voltage 2 > 28.8V (24V*1.2) [1]	UINT	RO	0x0000
4x9904	Under_Voltage_2	Voltage 2 < 19.2V (24V*0.8) [1]	UINT	RO	0x0000
4x9905	Over_Current	Bus current > 2A [1]	UINT	RO	0x0000
4x9906	Voltage_1	Input voltage 1	UINT	RO	0x0000
4x9907	Voltage_2	Input voltage 2	UINT	RO	0x0000
4x9908	Current	Input current	UINT	RO	0x0000
4x9909	ID Switch	Rotary switch value	UINT	RO	0x0000
4x9910	Module_count	Current SubDevice Quantity (Reserved)	UINT	RO	0x0000
4x9911	Module_count	Current SubDevice Quantity [2]	UINT	RO	0x0000

Table 2.5: Input Data (4x9901 - 4x9913)					
4x9912	Cable_redundancy_status	Cable redundancy status	UINT	RO	0x0000
4x9913	Cable_redundancy_linking	Cable redundancy linking status	UINT	RO	0x0000

[1]: The formula to calculate the real voltage or current is as follows: Real Voltage/Current = (Measured voltage / 1000). For example, if the measured voltage is 24168, the real voltage would be 24.168 V.

[2]: This value won't count the AMAX-5070 and AMAX-5079.

Chapter 3

System Configuration

3.1 Connect and Search Modules

3.1.1 Searching for the Coupler

Right click Ethernet and select the Search Device (Figure 3.1). The default node name is AMAX-5070, which is the main node of the device.

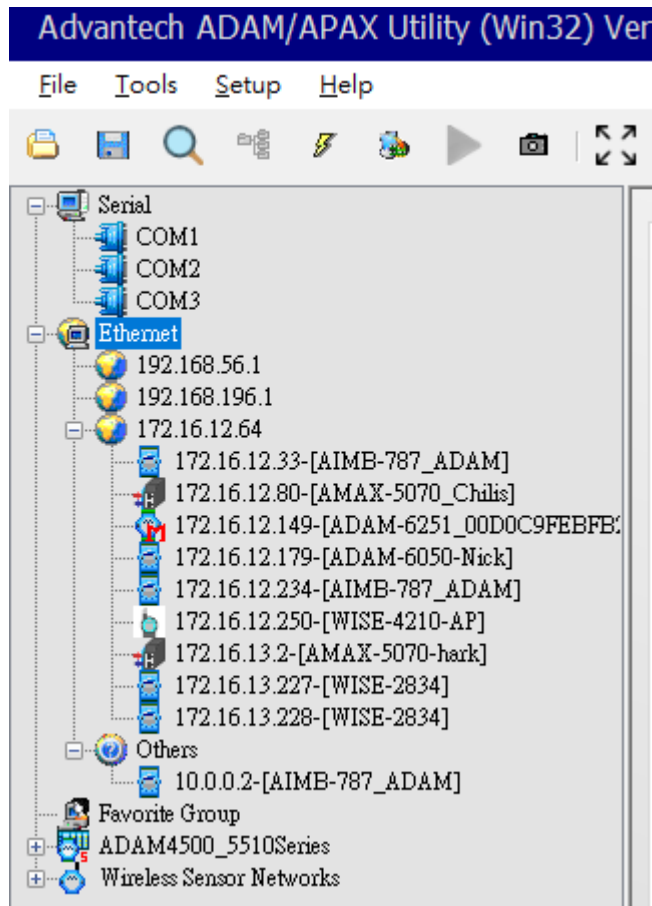

Figure 3.1 Searching for AMAX-5070

If Coupler (e.g. AMAX-5070, AMAX-5074) is under a different network segment, it will be displayed under the Others node (Figure 3.2).

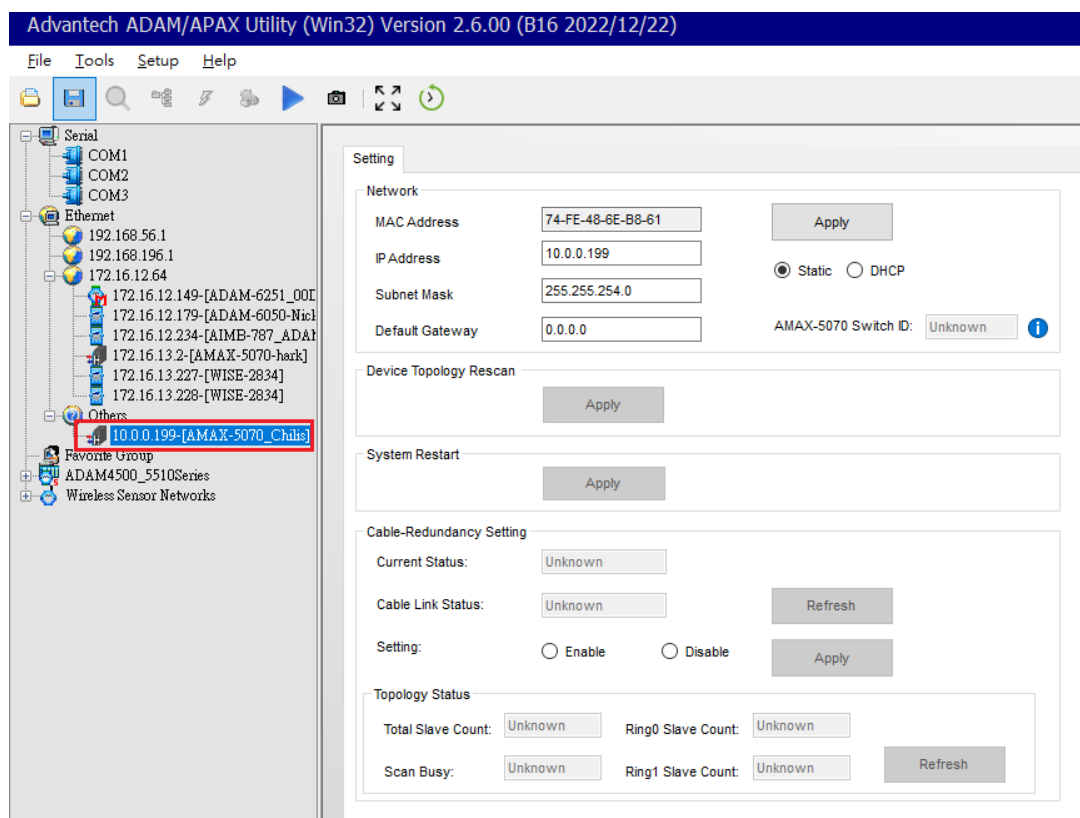

Figure 3.2 : AMAX-5070 in Different Network

3.1.2 Searching for the EtherCAT SubDevice

Clicking on the Coupler will display the current conditions and topology of the SubDevices. In the first layer, you will find the AMAX-5070 and AMAX-5074 device. In the second layer, you will find SubDevices such as AMAX-5024 and AMAX-5051. These SubDevices are positioned under either AMAX-5074 or AMAX-5070 (as shown in Figure 3.3). This hierarchical arrangement allows for a clear representation of the connectivity and placement of the SubDevices within the system.

The label "G0" after the Coupler name signifies Group 0. This number, representing the Group ID, will be automatically synchronized according to the rotary switch on the Coupler. For instance, if the rotary switch on an AMAX-5074 Coupler is set to (x16, x1)=(A,1), the Group ID will be set to G161.

However, in the case of AMAX-5070, the Group ID is always set to G0 (Group ID 0) and is not affected by the rotary switch on the Coupler. The Group ID for AMAX-5070 remains fixed and does not change based on the rotary switch position.

The label "S0" after the SubDevice name indicates that it is the first module connected in the whole system. In Figure 3.3, the first module is AMAX-5056, which has been assigned the label S0. The second module, which is an AMAX-5018, has been assigned the label S1. The third module, AMAX-5018, has been assigned the label S2.

If a module is not currently supported or recognized, it will be marked as Unknown. This typically occurs when the module is not compatible with the system or when its information is not available or updated in the current configuration.

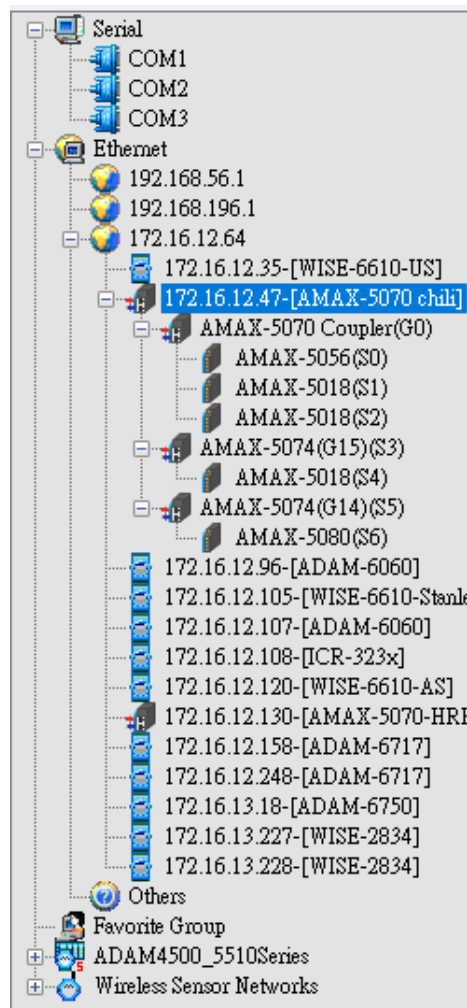

Figure 3.3 : The Subdevice Condition and Topology

The node will display an red exclamation mark "!" when there is a conflict with the Group ID.

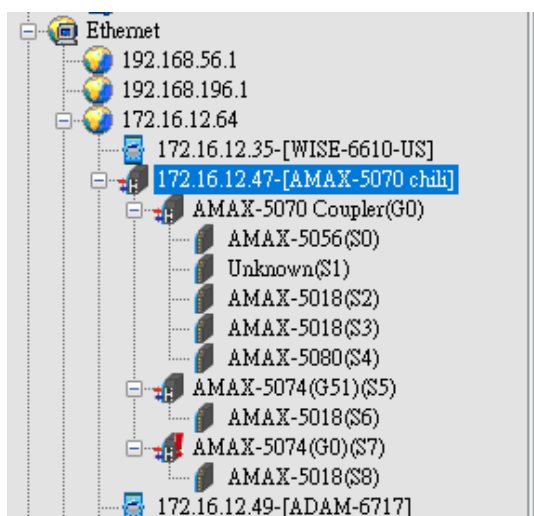

Figure 3.4 Group ID Conflict

3.2 Module Information

Clicking on the main node will display the information and configuration (Figure 3.5). If the following error message pops up, it indicates that the utility has recognized the same network segment but the command cannot reach the module due to subnet mask settings (Figure 3.6).

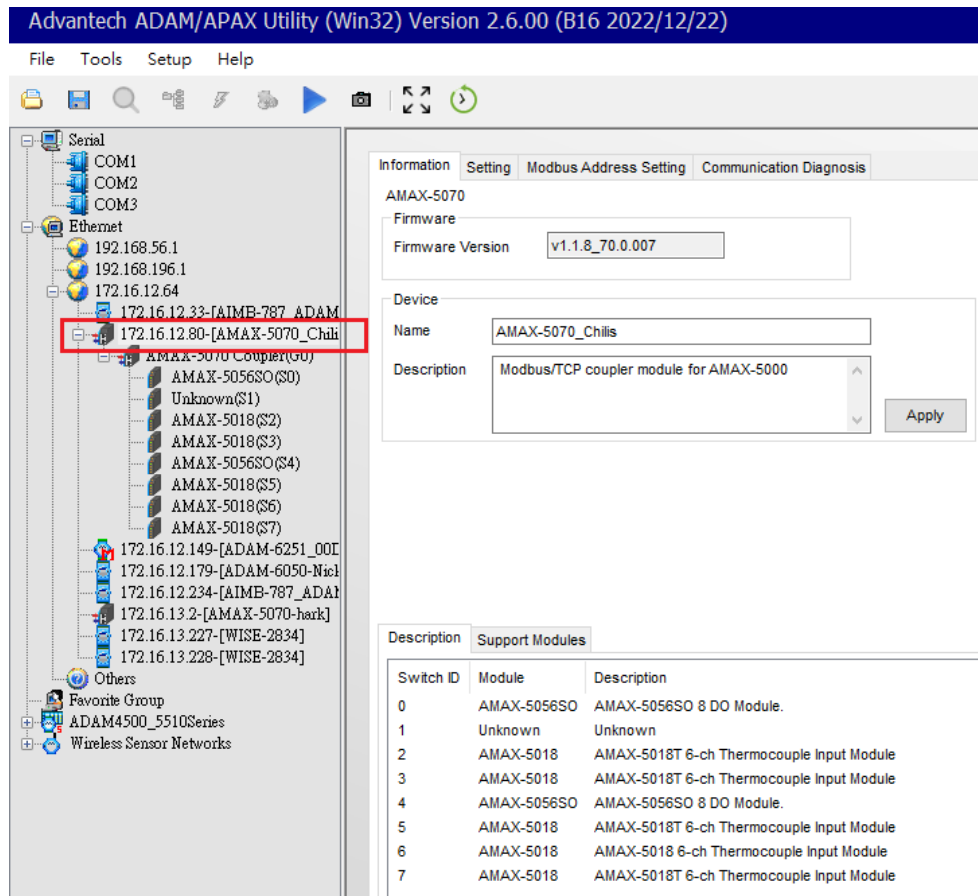

Figure 3.5 Coupler Configuration Page

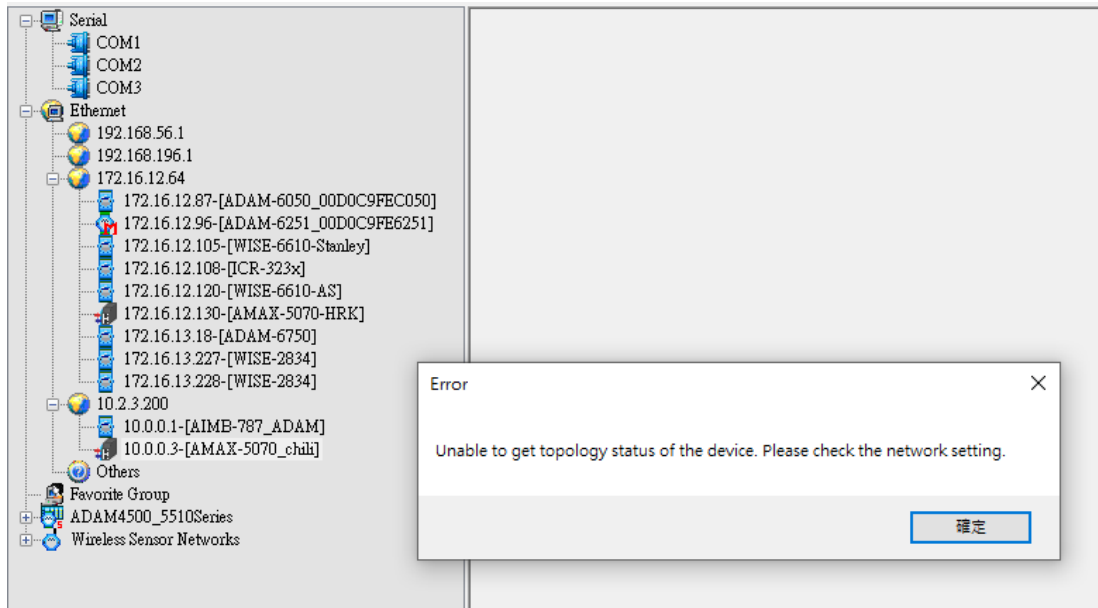

Figure 3.6 Different Subnet Mask Error

E.g.

If the Host IP is 10.2.3.200 with a subnet mask of 255.255.255.0, and the AMAX-5070's IP is 10.0.0.3 with a subnet mask of 255.0.0.0.

Both IP addresses have the first octet as 10, which leads the Utility to identify them as the same network segment.

However, due to the subnet mask configuration, the host and AMAX-5070 belong to different network segments (the host's network portion is 10.2.3.0, and AMAX-5070's network portion is 10.0.0.0), resulting in communication failure.

At this point, a page will appear allowing the user to reconfigure the IP address of AMAX-5070.(Figure 3.7)

If you do not want to change the IP addresses of both the Host and AMAX-5070, another approach is to modify the subnet mask of both devices to 255.0.0.0. By doing so, both devices will be within the same network (10.0.0.0), enabling proper communication between them.

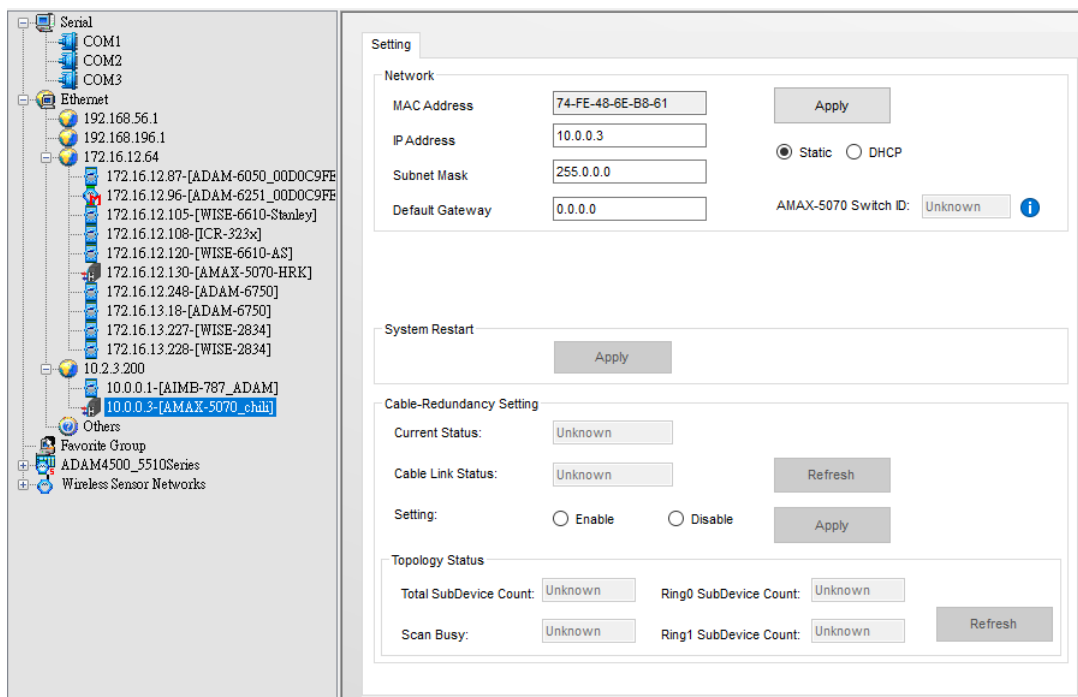

Figure 3.7 Re-setting the AMAX-5070 IP Address

For different network, the AMAX-5070 Coupler will display the Setting page if the module was in the different Internet segment.

In this condition, the user only can adjust the Internet configurations (e.g. IP address), the other option would be display Unknown, meaning it can't be adjusted. (Figure 3.8)

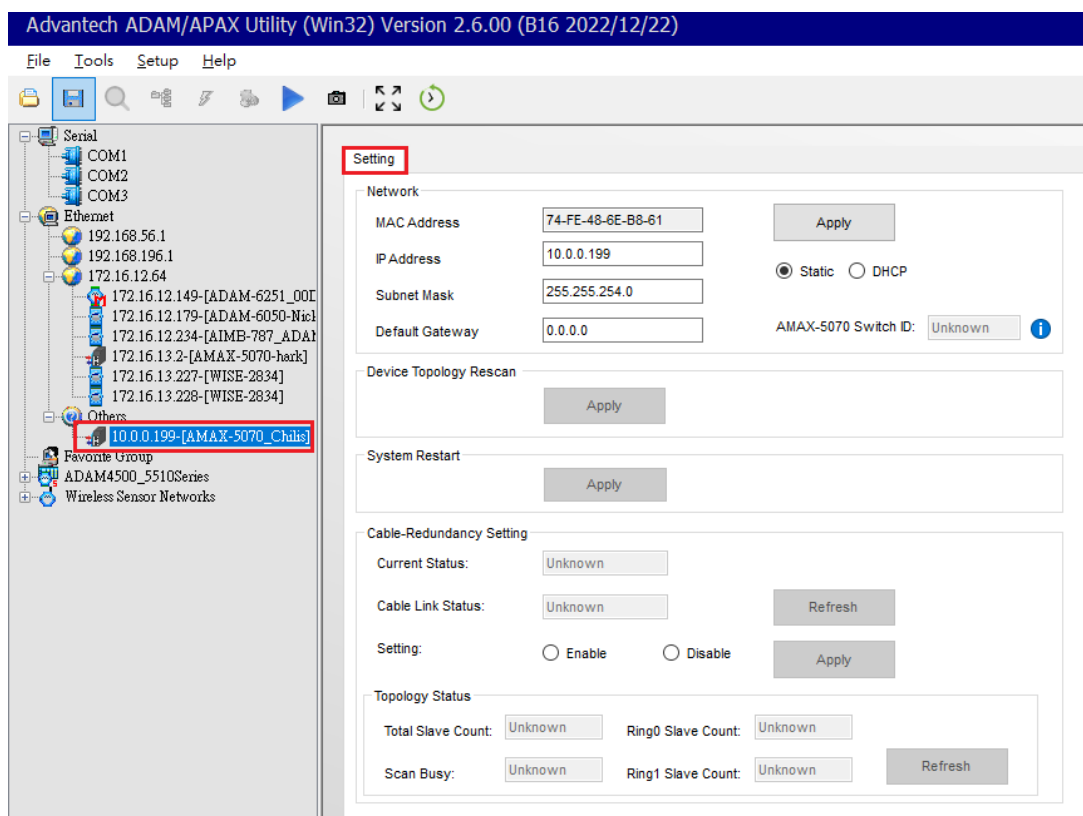

Figure 3.8 Coupler Configuration in Different Internet Segment

3.2.1 Main Node Information page (Coupler)

In the page Information will display Firmware Version and user can modify the Device Name and Description. (Figure 3.9)

Information Setting Modbus Address Setting Communication Diagnosis

AMAX-5070

Firmware

Firmware Version v1.1.8_70.0.007

Device

Name AMAX-5070_Chilis

Description Modbus/TCP coupler module for AMAX-5000

Apply

Figure 3.9 Coupler Information Page

3.2.2 Subordinate Node Information page (SubDevice)

The SubDevice node of Information will display Module, Current Connected Module and Description. (Figure 3.10)

Information Setting Modbus Address Setting Communication Diagnosis

AMAX-5070

Firmware

Firmware Version v1.1.8_70.0.007

Device

Name AMAX-5070_Chilis

Description Modbus/TCP coupler module for AMAX-5000

Apply

Description Support Modules

Switch ID	Module	Description
0	AMAX-5056SO	AMAX-5056SO 8 DO Module.
1	Unknown	Unknown
2	AMAX-5018	AMAX-5018T 6-ch Thermocouple Input Module
3	AMAX-5018	AMAX-5018T 6-ch Thermocouple Input Module
4	AMAX-5056SO	AMAX-5056SO 8 DO Module.
5	AMAX-5018	AMAX-5018T 6-ch Thermocouple Input Module
6	AMAX-5018	AMAX-5018 6-ch Thermocouple Input Module
7	AMAX-5018	AMAX-5018T 6-ch Thermocouple Input Module

Figure 3.10 SubDevice Information Page

3.2.3 SubDevice Support List

Click the Support Modules tab and check the supported SubDevices list (Figure 3.11).

Support Modules	Description
AMAX-5074	AMAX-5074 EtherCAT Coupler w/ ID Switch
AMAX-5001	AMAX-5001 Power Input w/ 4-ch DI Module
AMAX-5051	AMAX-5051 8-ch Digital Input Module
AMAX-5052	AMAX-5052 16-ch Digital Input Module
AMAX-5056	AMAX-5056 8-ch Sink Type Digital Output Module
AMAX-5056SO	AMAX-5056SO 8-ch Source Type Digital Output Module
AMAX-5057	AMAX-5057 16-ch Sink Type Digital Output Module
AMAX-5057SO	AMAX-5057SO 16-ch Source Type Digital Output Module
AMAX-5015	AMAX-5015 4-ch RTD Input Module
AMAX-5017V	AMAX-5017V 6-ch Voltage Input Module
AMAX-5017C	AMAX-5017C 6-ch Current Input Module
AMAX-5017H	AMAX-5017H 4-ch High Speed Analog Input Module
AMAX-5018	AMAX-5018 6-ch Thermocouple Input Module
AMAX-5024	AMAX-5024 4-ch Analog Output Module
AMAX-5080	AMAX-5080 2-ch 24V HTL Encoder/Counter Module
AMAX-5060	AMAX-5060 4-ch Relay w/ 2-ch DI Module

Figure 3.11 Support SubDevice List

3.3 Module Setting

3.3.1 Network Configuration

DHCP and Static Mode can be selected dependence on different applications. DHCP will be assigned internet configuration from DHCP server; In Static Mode user can modify IP address, Subnet Mask and Default Gateway. (Figure 3.12)

Information	Setting	Modbus Address Setting	Communication Diagnosis
Network			
MAC Address	74-FE-48-6E-B8-61		Apply
IP Address	172.16.12.80		<input type="radio"/> Static <input checked="" type="radio"/> DHCP
Subnet Mask	255.255.254.0		
Default Gateway	172.16.13.254		AMAX-5070 Switch ID: 32 (0x20) i

Figure 3.12 Network Configuration Page

3.3.2 AMAX-5070 Switch ID

AMAX-5070 rotary switch state would be displayed in the Setting page (Figure 3.13). For more information about switch ID function please check the blue information icon nearby the switch ID number.

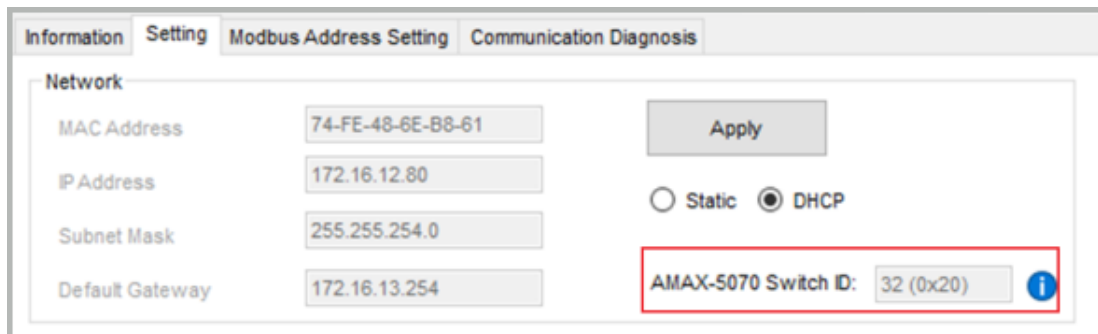

The screenshot shows the 'Setting' tab of the AMAX-5070 configuration interface. Under the 'Network' section, there are input fields for MAC Address (74-FE-48-6E-B8-61), IP Address (172.16.12.80), Subnet Mask (255.255.254.0), and Default Gateway (172.16.13.254). To the right of these fields is an 'Apply' button and radio buttons for 'Static' and 'DHCP' (which is selected). Below the network settings, the 'AMAX-5070 Switch ID' is set to '32 (0x20)' and is highlighted with a red box. A blue information icon is located to the right of the switch ID field.

Figure 3.13 AMAX-5070 Switch ID

3.3.3 Rescan the SubDevice and Topology

User can rescan the SubDevice and Topology in Device Topology Rescan then click the Apply button. (Figure 3.14)

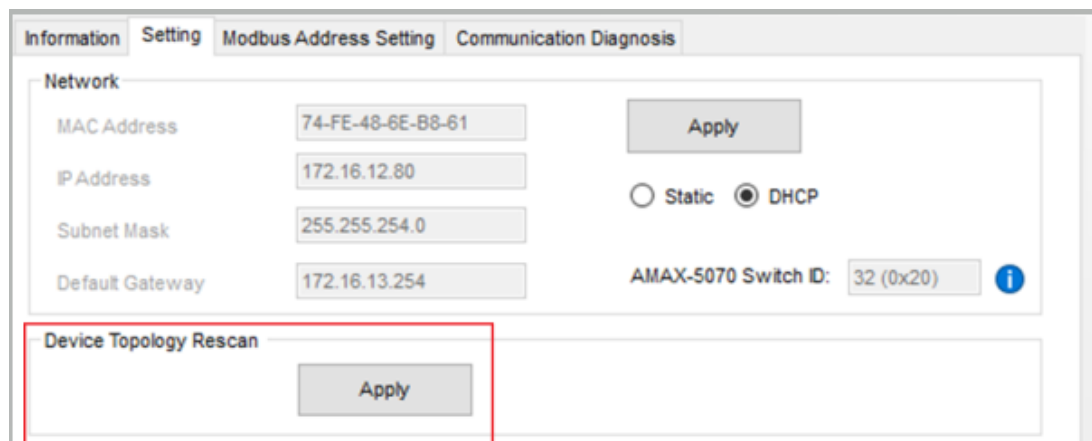

This screenshot shows the same 'Setting' tab as Figure 3.13. In addition to the network settings, there is a 'Device Topology Rescan' section at the bottom, which is highlighted with a red box. It contains an 'Apply' button. The 'AMAX-5070 Switch ID' field and its information icon are also visible in this view.

Figure 3.14 Rescan Function

If the AMAX-5070 connects to more than 255 SubDevices or the topology changed during the scan progress, the Utility will display Error (Figure 3.15).

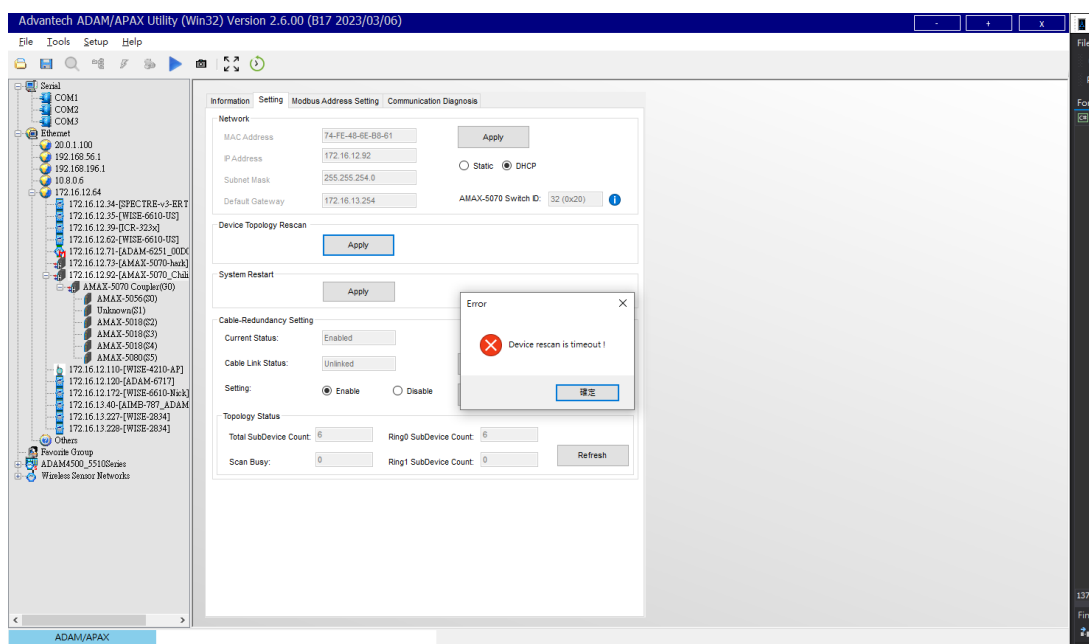

Figure 3.15 Time out

3.3.4 Restart the OS of the AMAX-5070

After clicking the **Apply** button, AMAX-5070 will rebooting the system (Figure 3.16).

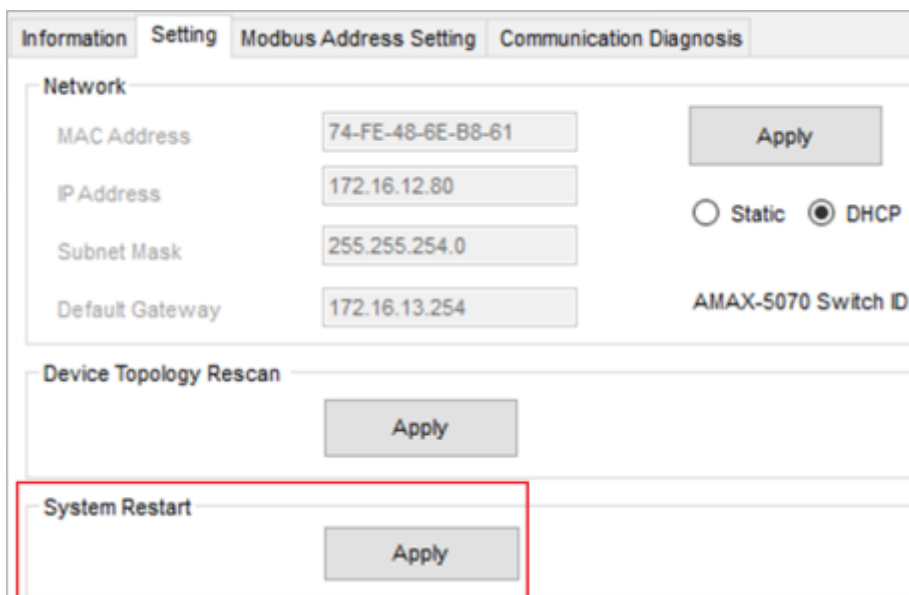

Figure 3.16 Restart the System

3.3.5 Cable Redundancy Configuration

The current status can be observed through Current Status and Cable Link Status, these two fields are not automatically updated, you need to click the Refresh button for acquiring the latest status.

User can select Enable/Disable button to select the cable redundancy and click the Apply to save setting (Figure 3.17).

The screenshot shows the 'Setting' tab of the AMAX-5070 web interface. The 'Cable-Redundancy Setting' section is highlighted with a red box. It contains the following fields and controls:

- Network:** MAC Address (74-FE-48-6E-B8-61), IP Address (172.16.12.80), Subnet Mask (255.255.254.0), Default Gateway (172.16.13.254). Includes an 'Apply' button and radio buttons for 'Static' and 'DHCP' (selected).
- Device Topology Rescan:** An 'Apply' button.
- System Restart:** An 'Apply' button.
- Cable-Redundancy Setting (highlighted):** Current Status (Disabled), Cable Link Status (Unlinked), Setting (radio buttons for 'Enable' and 'Disable', with 'Disable' selected). Includes 'Refresh' and 'Apply' buttons.
- Topology Status:** Total Slave Count (8), Ring0 Slave Count (8), Scan Busy (0), Ring1 Slave Count (0). Includes a 'Refresh' button.

Figure 3.17 Cable Redundancy Setting

When set to Enable and click Apply, a notification pops up to remind the user to confirm the wiring (Figure 3.18).

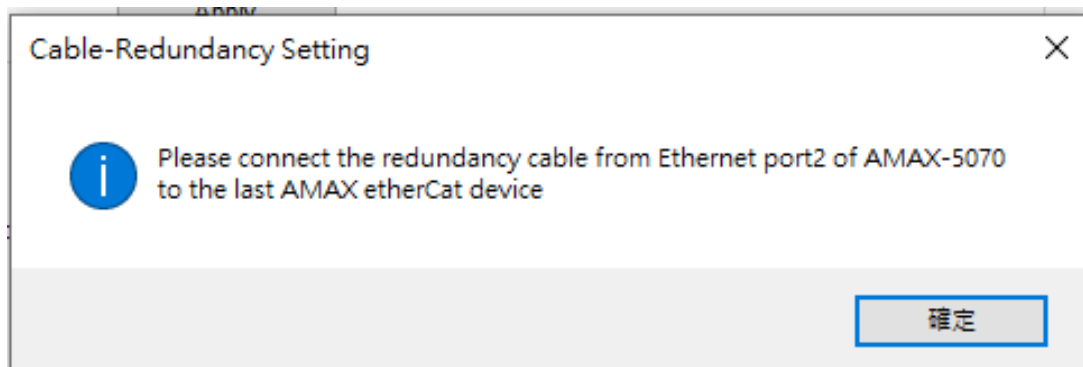

Figure 3.18 Cable Redundancy Notification for Wiring

And it informs the user of the upper time limit that may be consumed (Figure 3.19).

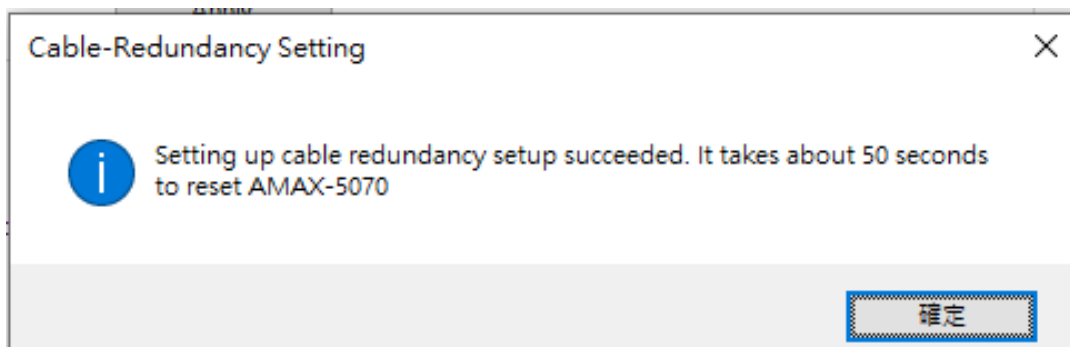

Figure 3.19 Cable Redundancy Notification for Estimated Reset Time

When Cable-Redundancy has been modified to Disable, the notification will remind users to remove the LAN 2 wiring.

3.3.6 Obtaining the Topology Status

This contains several bits of information (Figure 3.20):

1. Total SubDevice Count: The total number of SubDevices
2. Ring0 SubDevice Count: The number of SubDevices detected through Ethernet port1
3. Ring1 SubDevice Count: The number of SubDevices detected through Ethernet port2 (is only enabled in cable-redundancy if it has been set to “Enable”, otherwise the value would be set to 0).
4. Scan Busy: 0 for non-busy, 1 for busy (If Scan Busy value =1, AMAX-5070 internal system is working with each SubDevice for re-establishes the topology. At this time the SDO command doesn't work, only the PDO data can operate).

Information Setting **Modbus Address Setting** Communication Diagnosis

Network

MAC Address: 74-FE-48-6E-B8-61

IP Address: 172.16.12.102 Static DHCP

Subnet Mask: 255.255.254.0

Default Gateway: 172.16.13.254 AMAX-5070 Switch ID: 32 (0x20)

Device Topology Rescan

System Restart

Cable-Redundancy Setting

Current Status: Disabled

Cable Link Status: Unlinked

Setting: Enable Disable

Topology Status

Total SubDevice Count: 1 Ring0 SubDevice Count: 1

Scan Busy: 0 Ring1 SubDevice Count: 0

Figure 3.20 Topology Status

3.4 Modbus Address Setting

To adjust the Fixed Mode or Flexible Mode and obtain the corresponding Modbus addresses, click on Modbus Mapping.

For the AMAX-5070 device, the Modbus client address should always be set to Group 0 (G0), and it is not affected by the rotary switch on the device (as shown in Figure 3.21). But the rotary switch value will show on MainDevice.

However, for the AMAX-5074 device, both the Advantech Utility Group ID and Modbus client Device ID will automatically synchronize with the value set on the rotary switch (as indicated in Table 3.1). It's important to note that the AMAX-5079 device does not occupy a Modbus address (as depicted in Figure 3.22).

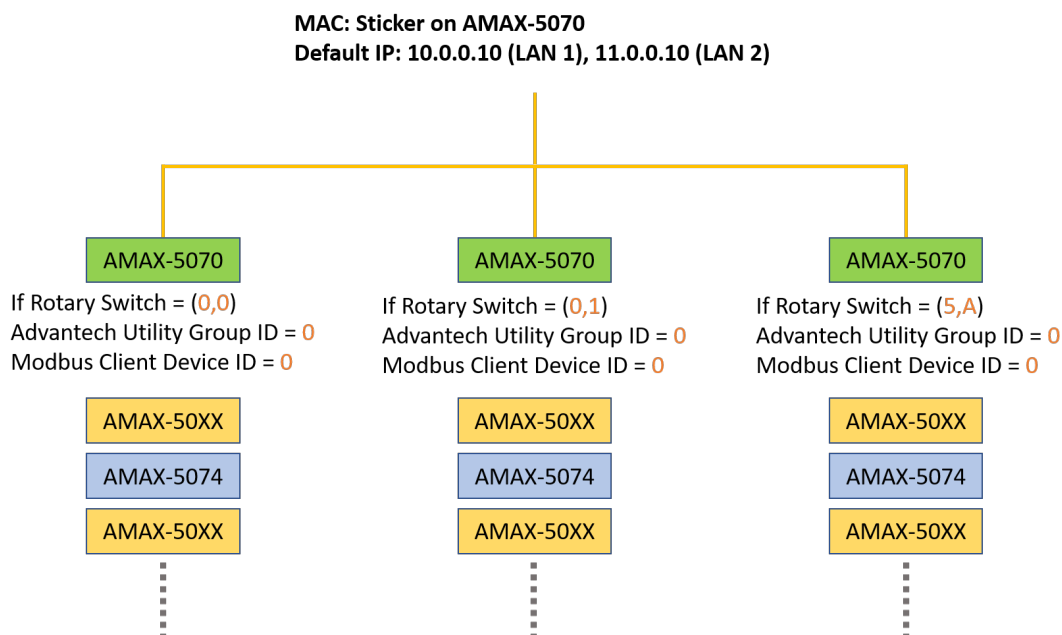

Figure 3.21 AMAX-5070 Modbus Client Address and Rotary Switch

Table 3.1: AMAX-5074 Group ID and Modbus Client Device ID		
AMAX-5074 Rotary Switch [1]	Advantech Utility Group ID	Modbus Client Device ID
(0, 0)	0	0
(0, 1)	1	1
(0, A)	10	10
(4, C)	76	76

[1]: (SW2, SW1) = (0, A), then ID = 0x16 + 10x1 = 10

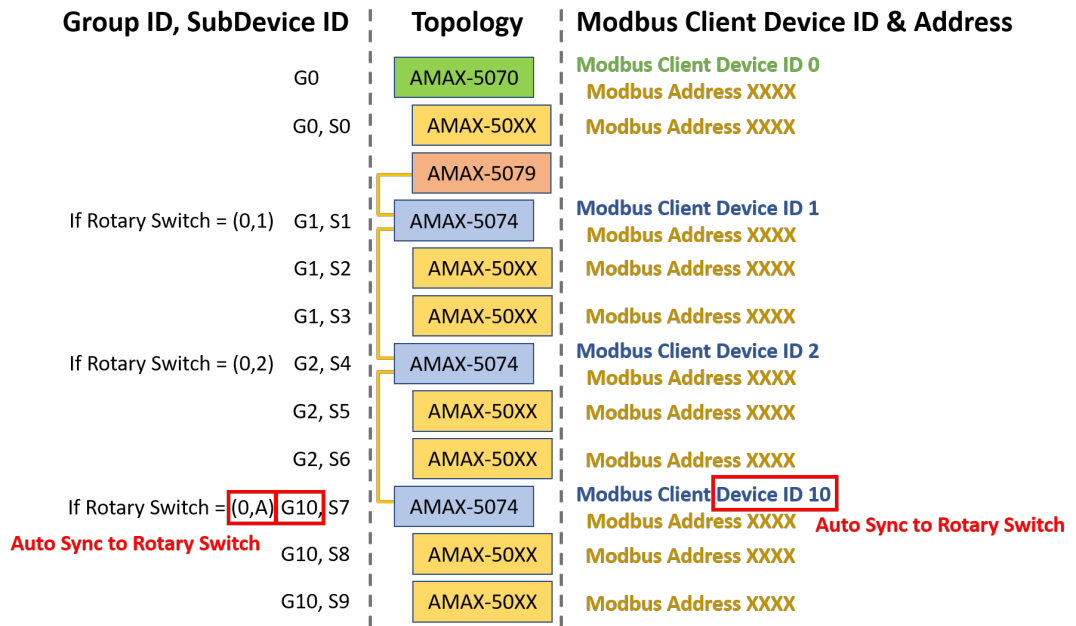

Figure 3.22 System Topology with Group ID and Device ID

Modbus address will change depending on which mode (Fixed Mode or Flexible Mode) or Group ID are currently used (Figure 3.23).

Modbus Address	Group ID 0	Modbus Address	Group ID 1 to 255
0000	SubDevices	0000	SubDevices
4900		4900	
4901	AMAX-5070 Reserved	5000	SubDevices
5000		5001	
5001	SubDevices	5001	SubDevices
9900		9900	
9901	AMAX-5070 Reserved	10000	SubDevices
10000		10000	

Figure 3.23 Modbus Address in Different Group ID and User Mode

3.4.1 Modbus Addresses for Connected Modules (Fixed Mode)

Click on Fixed Mode to obtain the current Modbus Address and Topology (Figure 3.24).

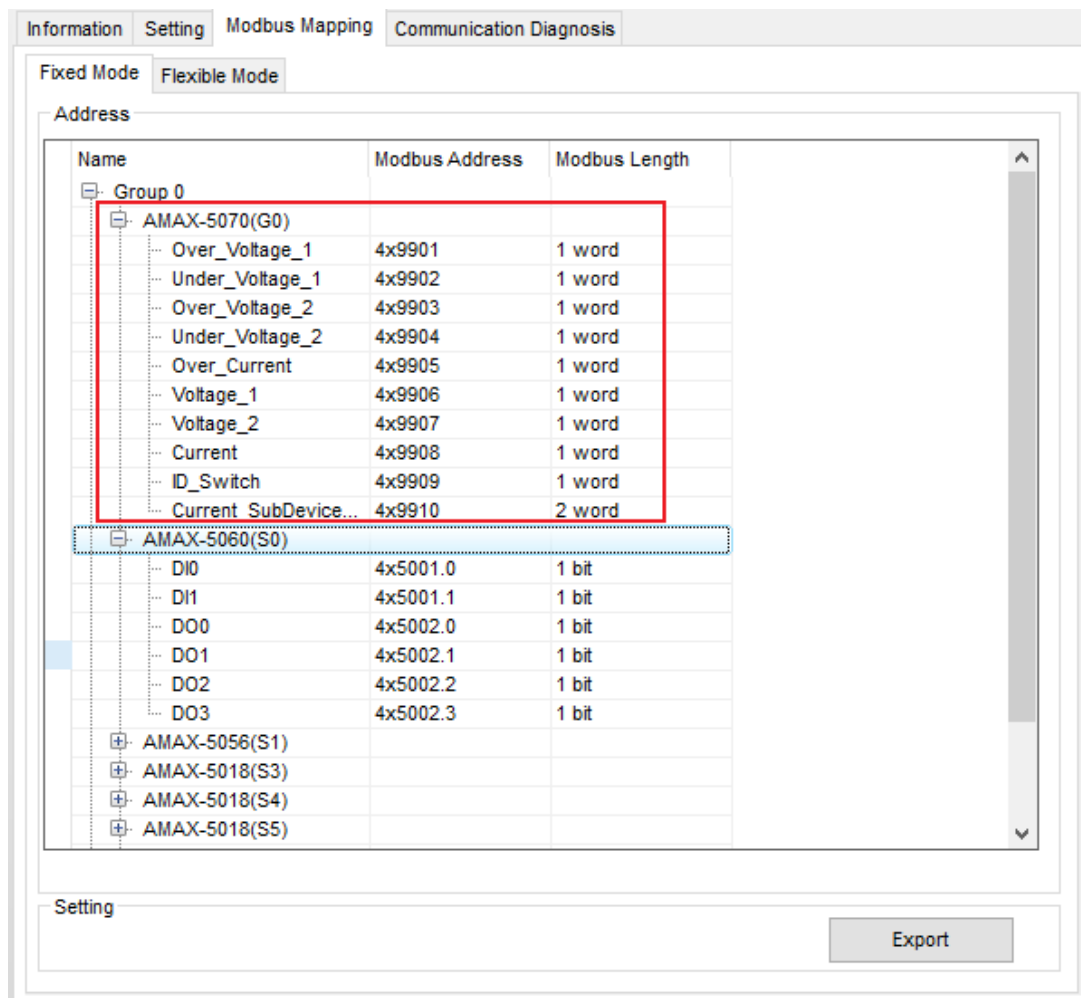

Figure 3.24 Modbus Address Setting Page

Modbus address will be reserved but won't display in the Advantech Utility because the unknown device occupies an address (Figure 3.25).

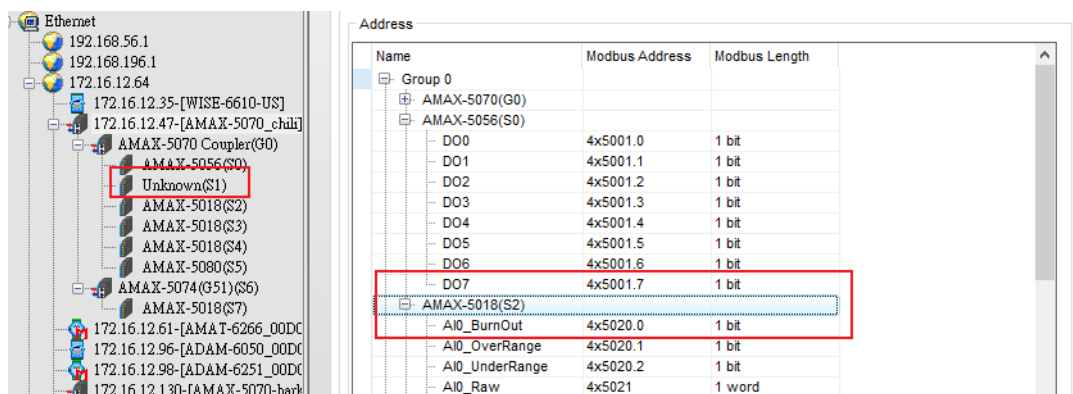

Figure 3.25 Modbus Address

3.4.2 Export the List of Modbus TCP Addresses for All Modules

Press the Export button to export the list with CSV file (Figure 3.26).



Figure 3.26 Export the ModBus TCP Address in Fixed Mode

The CSV file will be downloaded (Figure 3.27).

	A	B	C	D	E
1	StartAddress	AddressLength	Data Type	ModuleName	AddressName
2	4x9901	1 word	UINT	AMAX-5070(G0)	Over_Voltage_1
3	4x9902	1 word	UINT	AMAX-5070(G0)	Under_Voltage_1
4	4x9903	1 word	UINT	AMAX-5070(G0)	Over_Voltage_2
5	4x9904	1 word	UINT	AMAX-5070(G0)	Under_Voltage_2
6	4x9905	1 word	UINT	AMAX-5070(G0)	Over_Current
7	4x9906	1 word	UINT	AMAX-5070(G0)	Voltage_1
8	4x9907	1 word	UINT	AMAX-5070(G0)	Voltage_2
9	4x9908	1 word	DINT	AMAX-5070(G0)	Current
10	4x9909	1 word	UINT	AMAX-5070(G0)	ID_Switch
11	4x9910	2 word	UINT	AMAX-5070(G0)	Current_SubDevice_Count
12	4x5001.0	1 bit	BOOL	AMAX-5060(S0)	DI0
13	4x5001.1	1 bit	BOOL	AMAX-5060(S0)	DI1
14	4x5002.0	1 bit	BOOL	AMAX-5060(S0)	DO0
15	4x5002.1	1 bit	BOOL	AMAX-5060(S0)	DO1
16	4x5002.2	1 bit	BOOL	AMAX-5060(S0)	DO2
17	4x5002.3	1 bit	BOOL	AMAX-5060(S0)	DO3
18	4x5003.0	1 bit	BOOL	AMAX-5056(S1)	DO0
19	4x5003.1	1 bit	BOOL	AMAX-5056(S1)	DO1
20	4x5003.2	1 bit	BOOL	AMAX-5056(S1)	DO2
21	4x5003.3	1 bit	BOOL	AMAX-5056(S1)	DO3
22	4x5003.4	1 bit	BOOL	AMAX-5056(S1)	DO4
23	4x5003.5	1 bit	BOOL	AMAX-5056(S1)	DO5
24	4x5003.6	1 bit	BOOL	AMAX-5056(S1)	DO6
25	4x5003.7	1 bit	BOOL	AMAX-5056(S1)	DO7

Figure 3.27 Modbus TCP Addresses and Modules List in CSV File (Fixed Mode)

3.4.3 Modbus Addresses for Connected Modules (Flexible Mode)

The Flexible Mode will merge the Subdevices based on the functions and features. The catalog will be hidden if it doesn't have any modules.

DO Control
 AO Control
 Counter Control
 DI Status
 AO Status
 AI Status
 Counter Status
 System Status

Modbus address will display in Flexible Mode, click the Flexible Mode tab in the Modbus Address Setting (Figure 3.28).

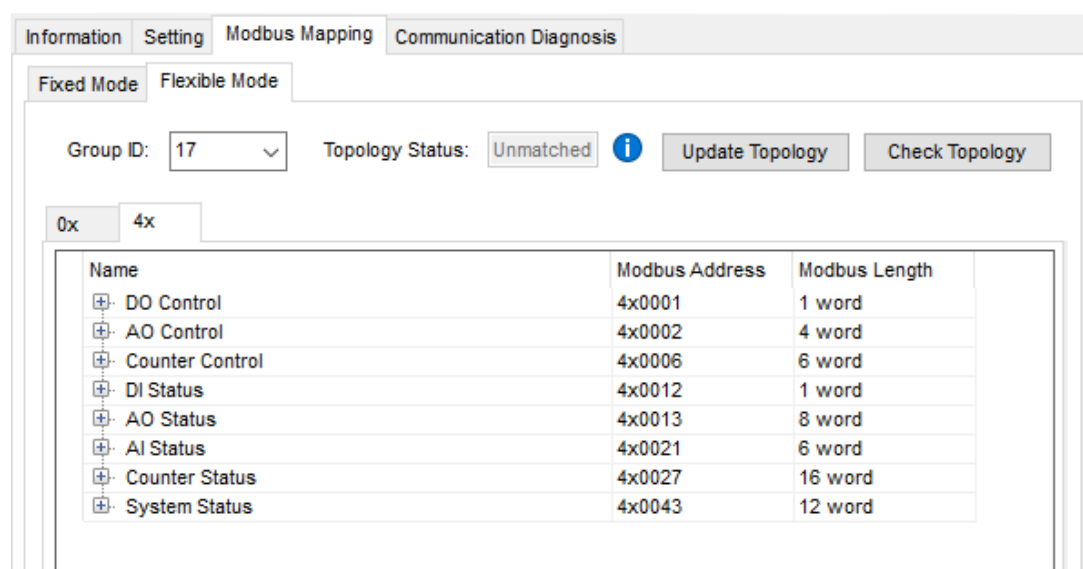

Figure 3.28 Flexible Mode

Flexible mode is used Group ID to manage the SubDevices. Change the Group ID number to modify the SubDevice configurations in this group. The Coil Status will be displayed in 0x tab (data size is bit, e.g. DI value, burnout status) and the Holding Register in 4x tab (data size is word) (Figure 3.29).

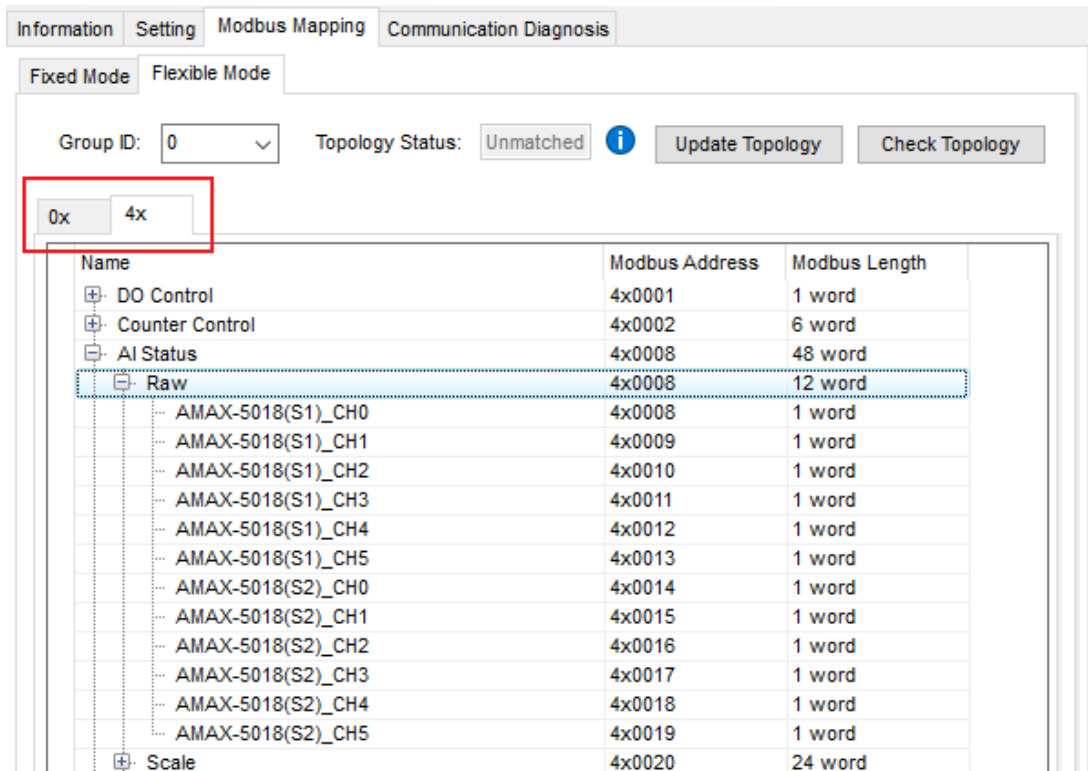

Figure 3.29 Modbus Coil Status and Holding Register

The Topology Status indicates whether the system is in flexible mode and if the Modbus address mapping is functioning correctly. Initially, the status is "Unmatched" which means that the AMAX-5070 device was not mapping the Modbus address. To save the current mapping and topology, click on the "Update" button.

After the update, the Topology Status will display either "Matched" if the current topology matches the saved one, or "Unmatched" if the current topology is different from the saved one (Figure 3.30).

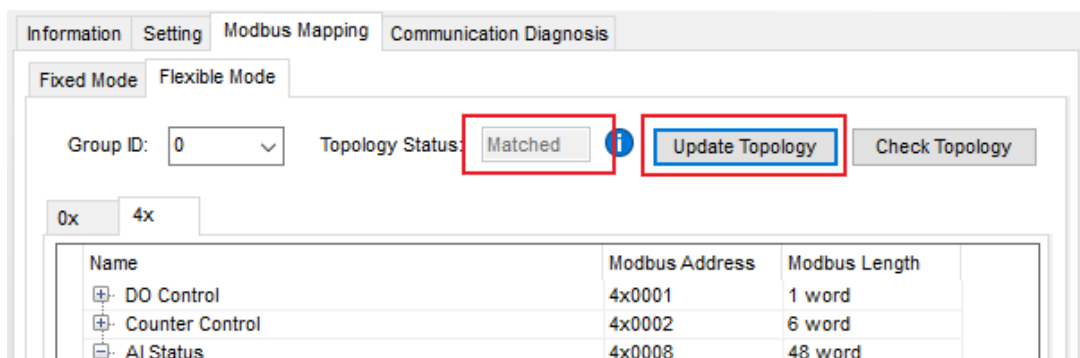

Figure 3.30 Flexible Mode Mapping Topology Status

After saving the current topology, click on "Check topology" to load the saved topology. If the current topology doesn't match the saved one, the system will mark the unmatched SubDevices in red (Figure 3.31).

After clicking on "Update Topology", the saved topology can be updated with any changes made to the current configuration. This allows you to save the latest changes to the topology.

On the other hand, clicking on "Clear Config file" will clear the saved configuration file, effectively removing the saved topology. This action will reset the configuration to its initial state before any changes were made.

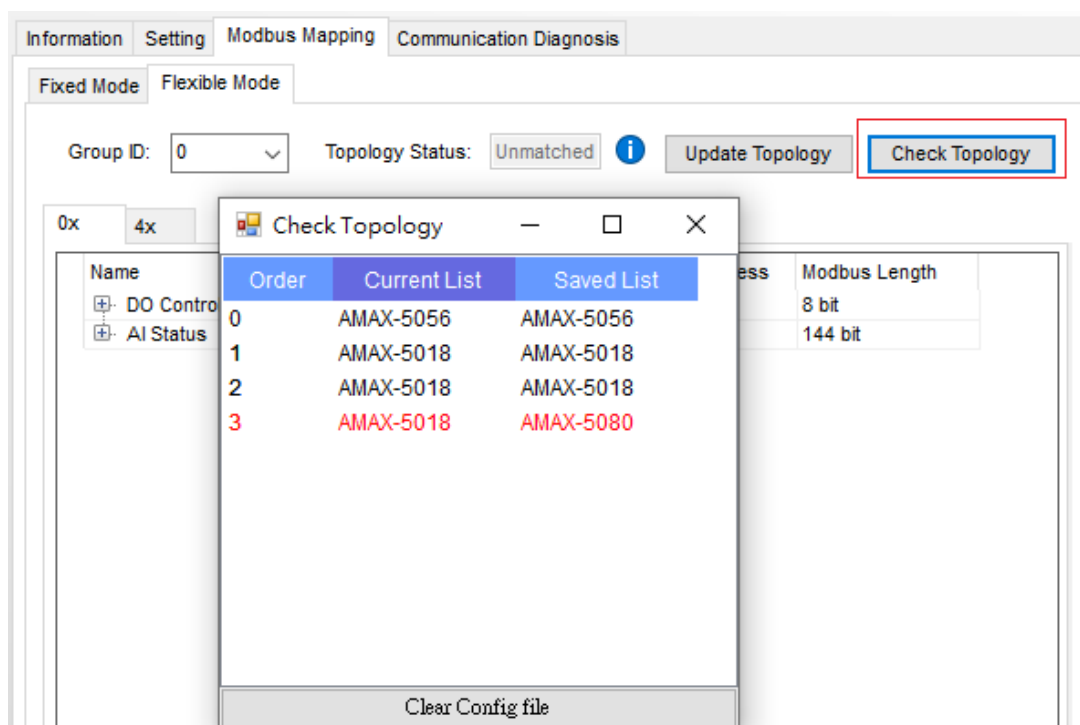

Figure 3.31 Check the Unmatched SubDevices

3.4.4 Export the List of Modbus TCP Addresses for All Modules (Flexible Mode)

Press the Export button to export the list with CSV file (Figure 3.32).

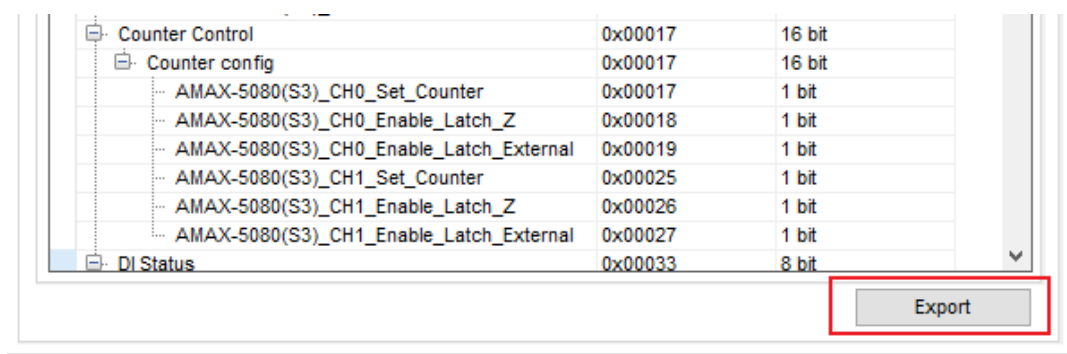

Figure 3.32 Export the ModBus TCP Address in Flexible Mode

The CSV file will be downloaded (Figure 10).

	A	B	C	D	E	F
1	StartAddress	AddressLength	Data Type	Catalog	Function	Device Description
2	0x0001	1 bit	BOOL	DO Control	Value	AMAX-5056(S0)_CH0
3	0x0002	1 bit	BOOL	DO Control	Value	AMAX-5056(S0)_CH1
4	0x0003	1 bit	BOOL	DO Control	Value	AMAX-5056(S0)_CH2
5	0x0004	1 bit	BOOL	DO Control	Value	AMAX-5056(S0)_CH3
6	0x0005	1 bit	BOOL	DO Control	Value	AMAX-5056(S0)_CH4
7	0x0006	1 bit	BOOL	DO Control	Value	AMAX-5056(S0)_CH5
8	0x0007	1 bit	BOOL	DO Control	Value	AMAX-5056(S0)_CH6
9	0x0008	1 bit	BOOL	DO Control	Value	AMAX-5056(S0)_CH7
10	0x0009	1 bit	BOOL	Counter Control	Counter config	AMAX-5080(S4)_CH0_Set_Counter
11	0x0010	1 bit	BOOL	Counter Control	Counter config	AMAX-5080(S4)_CH0_Enable_Latch_Z
12	0x0011	1 bit	BOOL	Counter Control	Counter config	AMAX-5080(S4)_CH0_Enable_Latch_External
13	0x0017	1 bit	BOOL	Counter Control	Counter config	AMAX-5080(S4)_CH1_Set_Counter
14	0x0018	1 bit	BOOL	Counter Control	Counter config	AMAX-5080(S4)_CH1_Enable_Latch_Z
15	0x0019	1 bit	BOOL	Counter Control	Counter config	AMAX-5080(S4)_CH1_Enable_Latch_External
16	0x0025	1 bit	BOOL	AI Status	BurnOut	AMAX-5018(S1)_CH0_BurnOut
17	0x0026	1 bit	BOOL	AI Status	BurnOut	AMAX-5018(S1)_CH0_OverRange
18	0x0027	1 bit	BOOL	AI Status	BurnOut	AMAX-5018(S1)_CH0_UnderRange

Figure 3.33 Modbus TCP Addresses and Modules List in CSV File (Flexible Mode)

3.4.5 Identify the Modules of Abnormal Communication

The modules can be highlighted if they communicate abnormally, click the Mark Communication Status under Communication Diagnosis page. The module will be highlighted by a yellow flag if the error counter goes over Error Threshold Middle value, or red flag if the error counter goes over the Error Threshold High value (Figure 3.34).

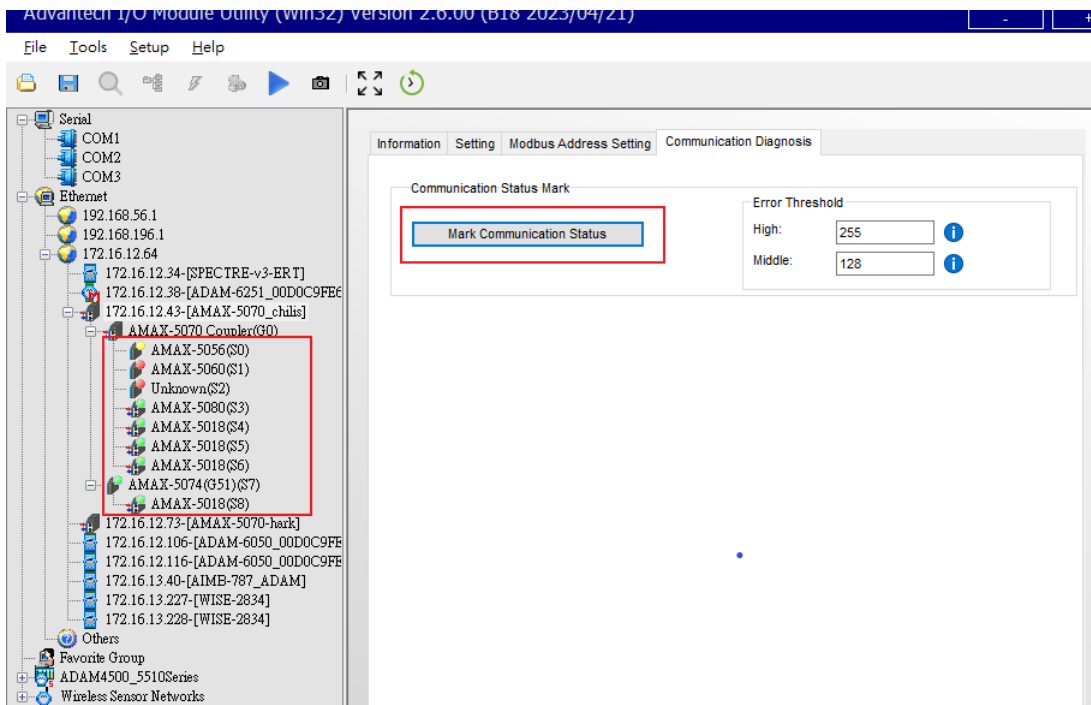

Figure 3.34 Mark Communication Status

If the module disconnects, it will be marked with "?" (Figure 3.35).

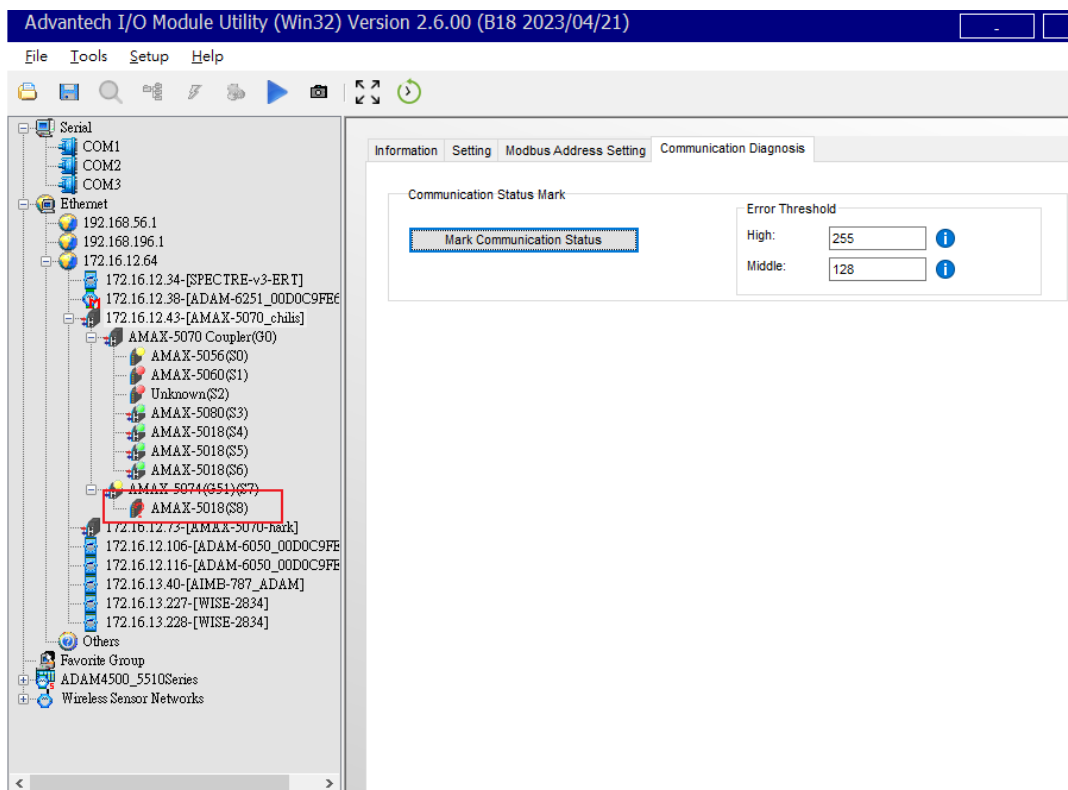

Figure 3.35 Mark Communication Status when Module disconnection

Chapter 4

Coupler and
SubDevice
Configuration

4.1 Coupler and SubDevice Configuration

4.1.1 Device Categories

It can be roughly divided into three categories (Figure 4.1):

- Coupler Modules with segmentation groups (AMAX5070, AMAX5074).
- Modules that don't have segmentation groups (SubDevices).
- Unknown SubDevices.

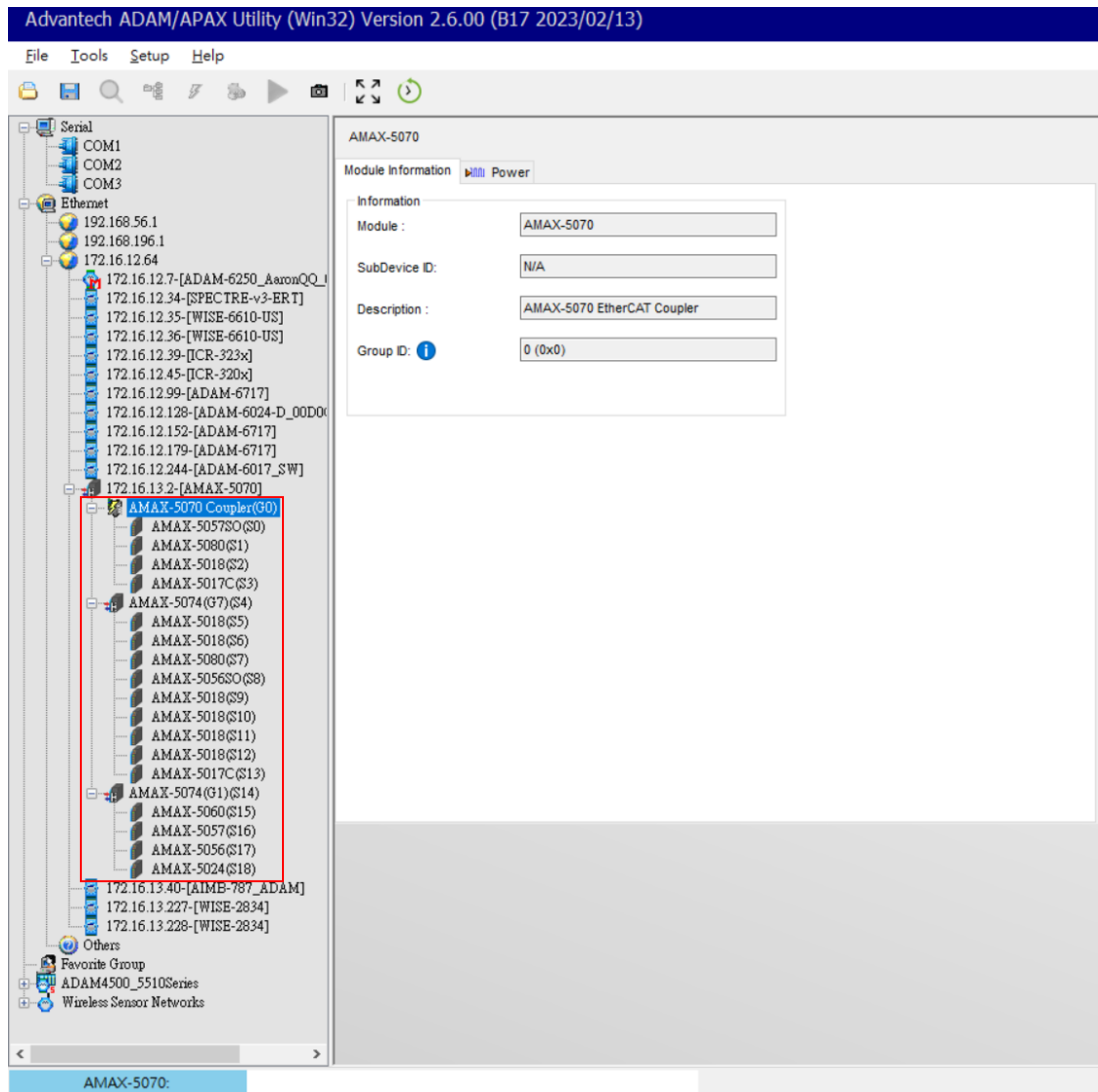
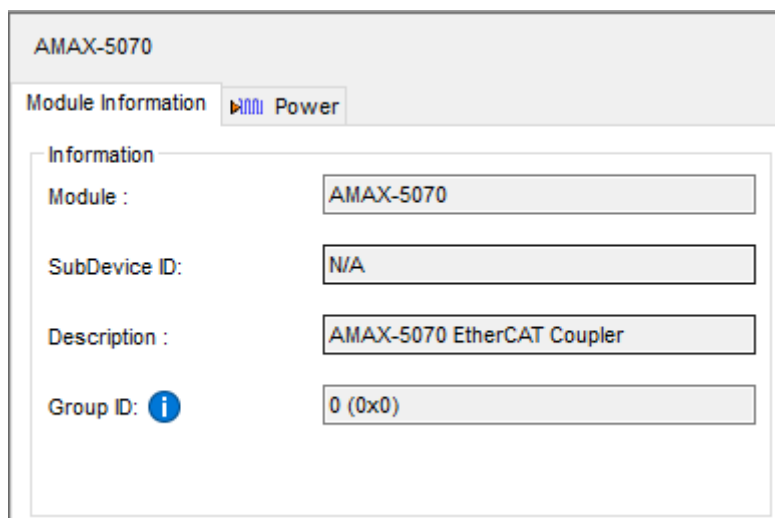

Figure 4.1 Device Categories

4.1.1.1 Coupler

Module Name, SubDevice ID (N/A as default), Description, and Group ID can be found in the Module Information page (Figure 4.2).



The screenshot shows the 'AMAX-5070' module configuration page. At the top, there are two tabs: 'Module Information' (selected) and 'Power'. Below the tabs is an 'Information' section with four rows of data:

Field	Value
Module :	AMAX-5070
SubDevice ID:	N/A
Description :	AMAX-5070 EtherCAT Coupler
Group ID: ⓘ	0 (0x0)

Figure 4.2 Coupler or Coordinator Module Information

4.1.1.2 SubDevice

In the SubDevice, information includes Module, SubDevice ID, and Description (Figure 4.3).

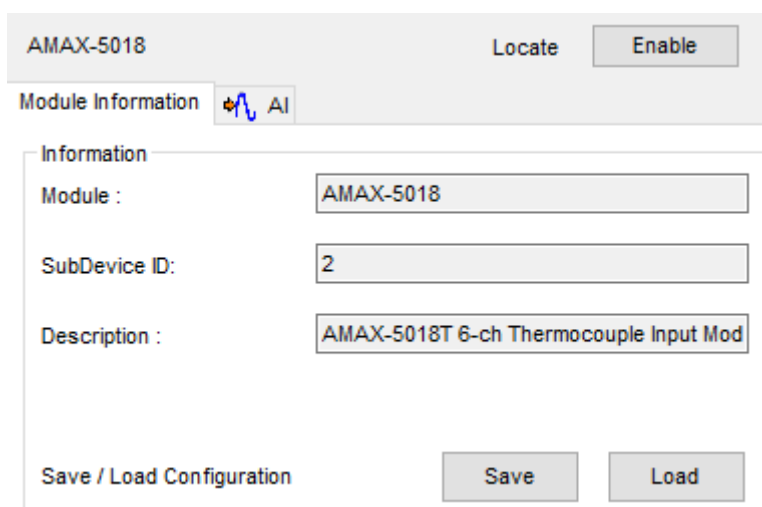

The screenshot shows the 'AMAX-5018' subdevice configuration page. At the top right, there are 'Locate' and 'Enable' buttons. Below this is the 'Module Information' section with a selected 'AI' tab. The 'Information' section contains three rows of data:

Field	Value
Module :	AMAX-5018
SubDevice ID:	2
Description :	AMAX-5018T 6-ch Thermocouple Input Mod

At the bottom, there is a 'Save / Load Configuration' section with 'Save' and 'Load' buttons.

Figure 4.3 SubDevice Information

4.1.1.3 Unknown SubDevices

For Unknown SubDevice, only SubDevice ID can be found (Figure 4.4).

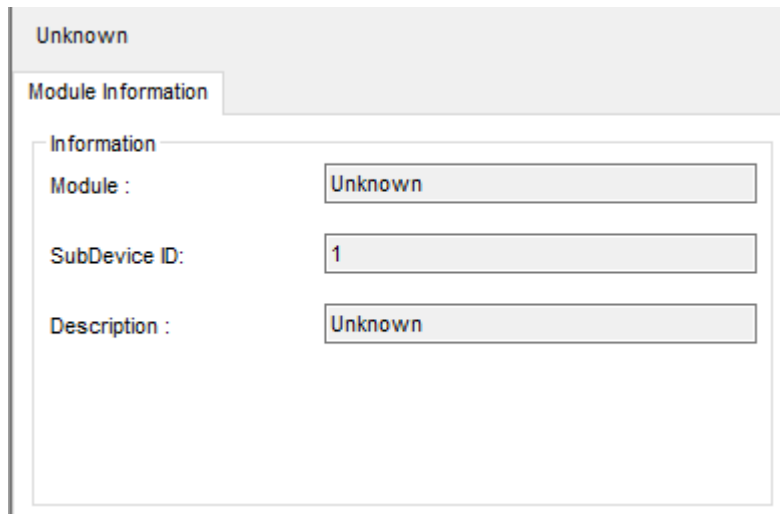

The screenshot shows a web interface for an 'Unknown' module. It features a 'Module Information' tab with an 'Information' section. The form contains three input fields: 'Module' with the value 'Unknown', 'SubDevice ID' with the value '1', and 'Description' with the value 'Unknown'.

Figure 4.4 Unknown Module Information

4.1.2 Storing and Loading Configurations

When the IO settings of a SubDevice are configurable, regardless of the number of sub-pages, the Load/Save configuration operation can be performed in the Module Information tab. For example, the configuration of the AI tab in the following figure can be saved or loaded through the button (Figure 4.5).

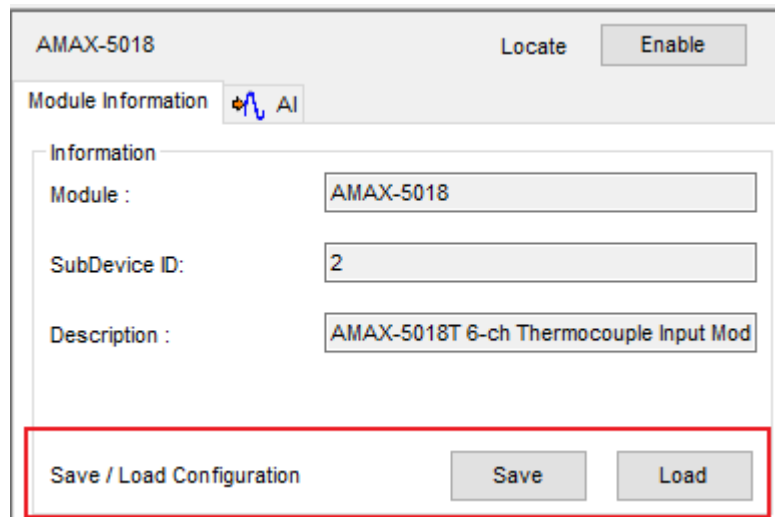

The screenshot shows the configuration page for an 'AMAX-5018' module. At the top, there are 'Locate' and 'Enable' buttons. Below is the 'Module Information' tab with an 'AI' sub-tab selected. The 'Information' section contains three input fields: 'Module' (AMAX-5018), 'SubDevice ID' (2), and 'Description' (AMAX-5018T 6-ch Thermocouple Input Mod). At the bottom, a red box highlights the 'Save / Load Configuration' section, which includes 'Save' and 'Load' buttons.

Figure 4.5 Save and Load Configuration

The configuration of DI/DO settings shown in the diagram can also be saved or loaded through the Save or Load button (Figure 4.6).

The screenshot shows the configuration interface for the AMAX-5060 module. At the top, there are buttons for 'Locate' and 'Enable'. Below this is the 'Module Information' section, which includes a red-bordered box containing 'DI' and 'DO' icons. The 'Information' section contains three text input fields: 'Module : AMAX-5060', 'SubDevice ID: 8', and 'Description : AMAX-5060 4-ch Relay w/ 2-ch DI Module'. At the bottom, there is a 'Save / Load Configuration' section with 'Save' and 'Load' buttons.

Figure 4.6 DI/DO Configuration

For SubDevices that do not support the save/load configuration feature, the Save and Load buttons will be hidden (Figure 4.7. For example, the AMAX-5056SO only supports setting and reading DO values, but doesn't support any DO configuration functions such as safety functions.

The screenshot shows the configuration interface for the AMAX-5056SO module. At the top, there are no 'Locate' or 'Enable' buttons. Below this is the 'Module Information' section, which includes a 'DO' icon. The 'Information' section contains three text input fields: 'Module : AMAX-5056SO', 'SubDevice ID: 4', and 'Description : AMAX-5056SO 8 DO Module.'. The 'Save / Load Configuration' section at the bottom is empty, indicating that the Save and Load buttons are hidden.

Figure 4.7 Example of Not Supported SubDevice UI

4.1.3 Locate SubDevices

Users can turn on the locate LED on the SubDevice when click the Enable button; click again will turn off the locate LED (Figure 4.8).

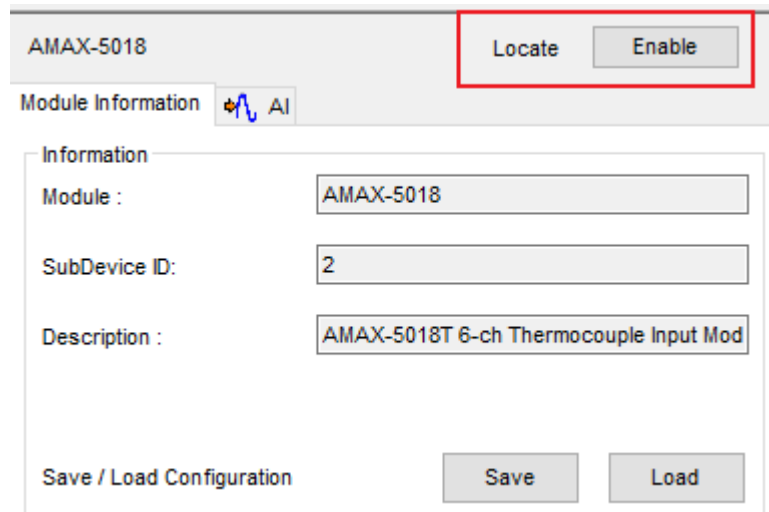

Figure 4.8 Locating SubDevice Function

For devices that do not support the Locate feature, the locate button is hidden (Figure 4.9).

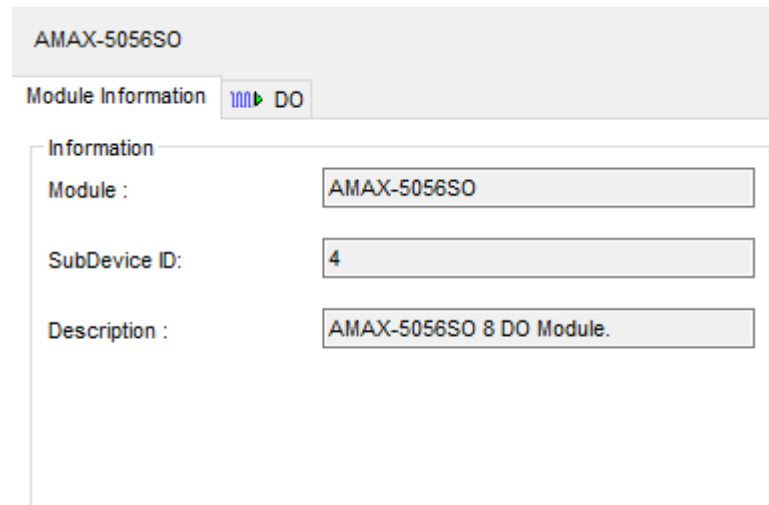

Figure 4.9 SubDevice without LED Locate Function

4.2 Obtain and Configure Coupler and SubDevice

4.2.1 Obtain Power SubDevices Status

Through the Power tab, you can get the current/voltage related status (Figure 4.10). The Channel information will display the value of current, voltage1, voltage2 and the corresponding Modbus address.

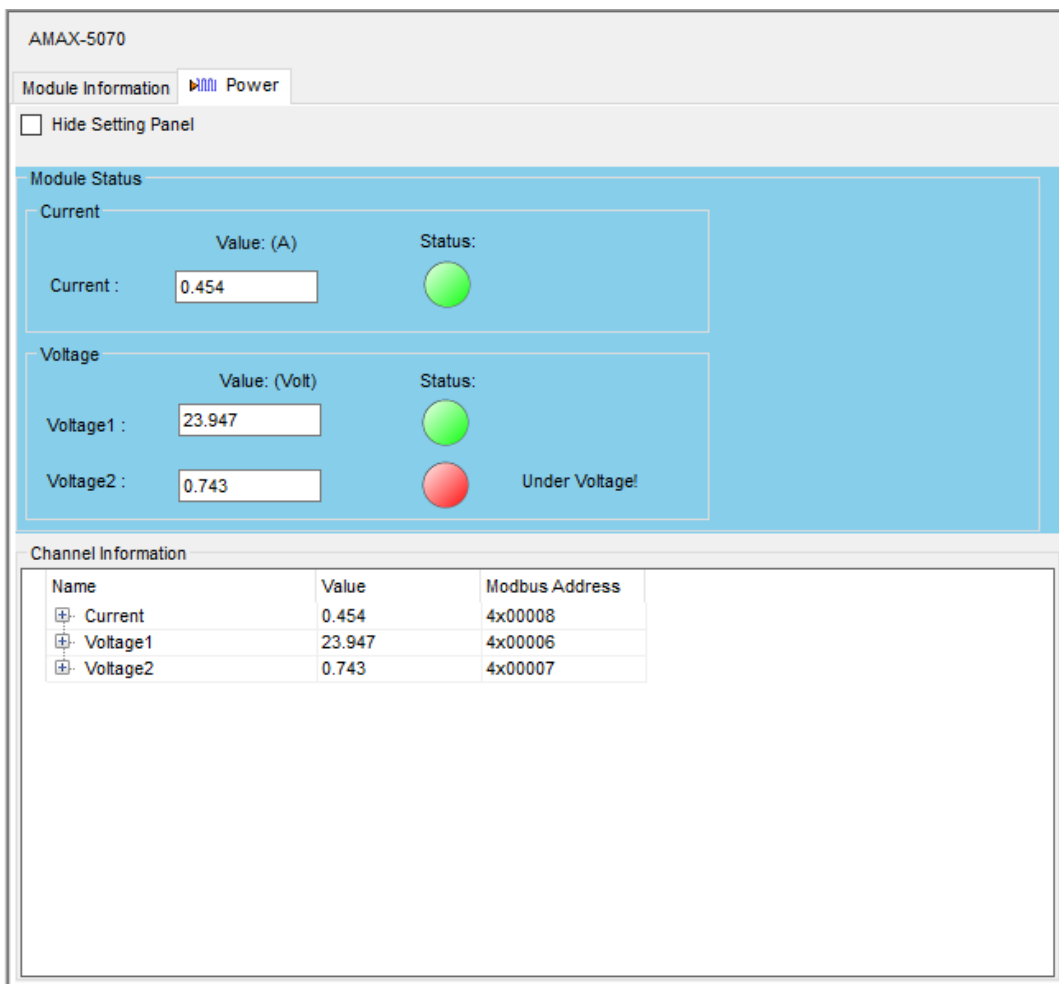

Figure 4.10 Power Status

The tree in Channel Information can be expanded to show more detailed information (Figure 4.11).

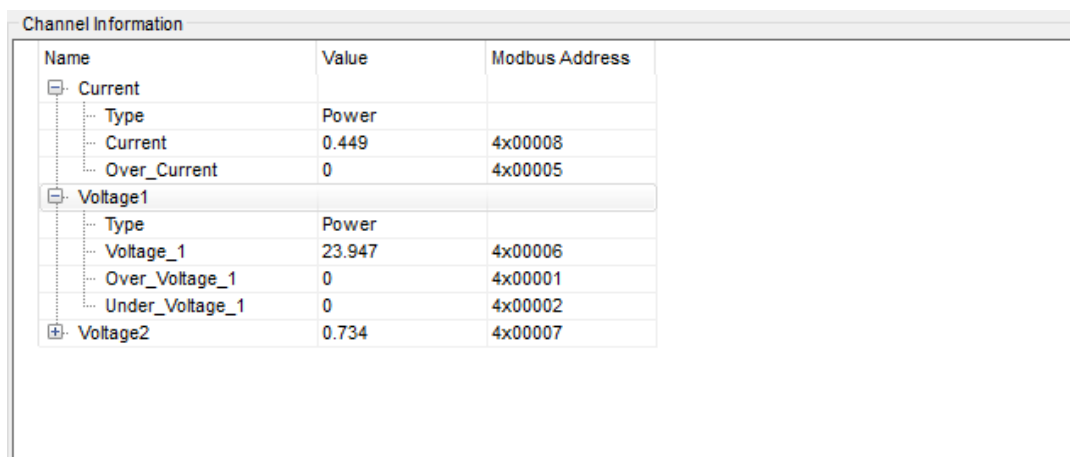

Figure 4.11 Power Status and Modbus Address Information

4.2.2 Analogue Input SubDevices

4.2.2.1 Obtain Analogue Input Status

Through the AI tab, users can obtain the AI-related status and the Modbus address in the channel information (Figure 4.12).

The screenshot displays the configuration interface for the AMAX-5018 Analogue Input (AI) module. At the top, the device name 'AMAX-5018' is shown, along with 'Locate' and 'Enable' buttons. Below this, the 'Module Information' tab is active, showing a 'Hide Setting Panel' checkbox. The main configuration area is divided into two sections: 'Selected Items' and 'Module setting'. The 'Selected Items' section includes an 'Apply to All Channels' checkbox, a 'Range' dropdown set to 'K 0~1370 °C' with an 'Apply' button, and a 'Burnout Detect' section with 'Enable' checked and 'Mode' set to 'Up Scale' with an 'Apply' button. The 'Module setting' section has a 'Sampling Rate' dropdown set to '600Hz' with an 'Apply' button. A 'Trend Log' button is also visible. At the bottom, the 'Channel Information' section contains a table with the following data:

Name	Value	Modbus Address
Ch0	1370.0	4x00106
Ch1	1370.0	4x00111
Ch2	1370.0	4x00116
Ch3	1370.0	4x00121
Ch4	1370.0	4x00126
Ch5	1370.0	4x00131

Figure 4.12 Analogue Input Status

The tree in Channel Information can be expanded to show more detailed information (Figure 4.13).

Name	Value	Modbus Address
Ch0		
Type	AI	
Scale	760.0	4x00106
Raw	FFFF	4x00104
BurnOut	True	4x00103.0
UnderRange	False	4x00103.2
OverRange	False	4x00103.1
Burnout Detect Enabled	True	
Burnout Detect Mode	Up Scale	
Range	J 0~760 °C	
Ch1	760.0	4x00111
Ch2	760.0	4x00116
Ch3	760.0	4x00121
Ch4	760.0	4x00126

Figure 4.13 Analogue Input Value and Modbus Address Information

4.2.2.2 Configure Analogue Input

Channel information can be configured in different range. For example, we want to set the channel 1 input range from K to $\pm 2.5V$.

1. Expand the channel's tree and the selected Items will be shown in the blue area (Figure 4.14).

AMAX-5018 Locate Enable

Module Information AI

Hide Setting Panel

Selected Items

Apply to All Channels

Range : K 0~1370 °C Apply

Burnout Detect

Enable

Mode: Up Scale Apply

Module setting

Sampling Rate: 600Hz Apply

Channel Information

Name	Value	Modbus Address
Ch0	1370.0	4x00106
Ch1	1370.0	4x00111
Ch2	1370.0	4x00116
Ch3	1370.0	4x00121
Ch4	1370.0	4x00126
Ch5	1370.0	4x00131

Figure 4.14 Expand the Tree and Change the AMAX-5018 Range

- Select the range $\pm 2.5V$ and click the Apply button. Users also can apply the setting to all channels (Figure 4.15).

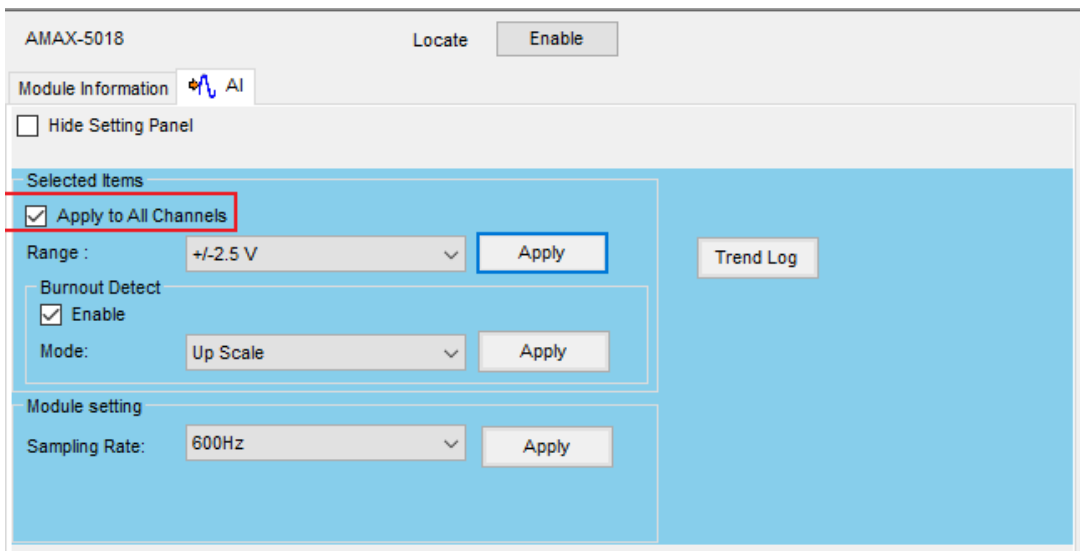

Figure 4.15 Apply the Change for All Channels of This SubDevice

4.2.3 Analogue Output SubDevices

4.2.3.1 Obtain Analogue Output Status

Through the AO tab, users can obtain the AO-related status and the Modbus address in the channel information (Figure 4.16).

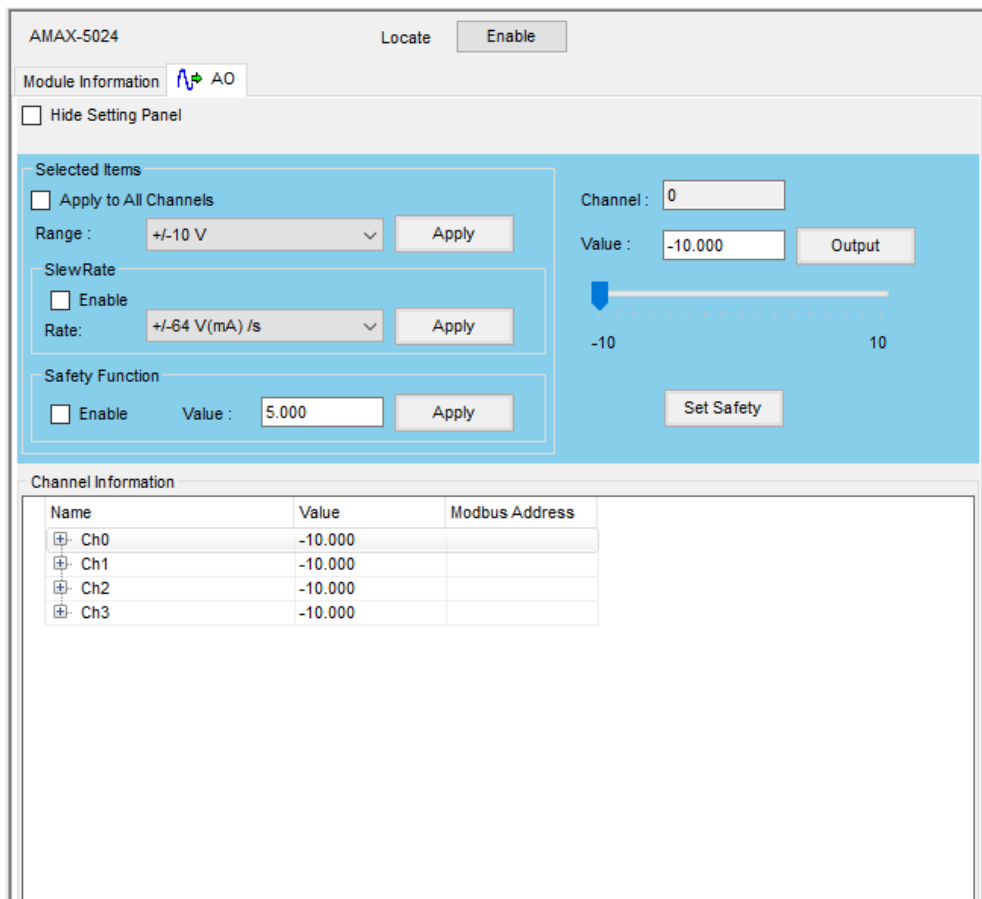

Figure 4.16 Analogue Output Status

The tree in Channel Information can be expanded to show more detailed information (Figure 4.17).

Name	Value	Modbus Address
Ch0		
Type	AO	
ReadBack	0000	4x22014
ReadBack_Scale	-10.000	
Output	0000	4x22022
BurnOut	False	4x22013.0
Range	+/-10 V	
Safety Value Enable	False	
Safety Value	5.000	
Slew Rate Enable	False	
Slew Rate	+/-64 V(mA) /s	
Ch1	-10.000	
Ch2	-10.000	
Ch3	-10.000	

Figure 4.17 Analogue Output Value and Modbus Address Information

4.2.3.2 Configure Analogue Output

Channel information can be configured in different ranges. For example, if we want to change the channel 0 input range (Figure 4.18).

1. Expand the channel's tree and the selected Items will be shown on the blue area.
2. Select the ranges you want and click the Apply button. Users also can apply the setting to all channels.

AMAX-5024 Locate Enable

Module Information AO

Hide Setting Panel

Selected Items

Apply to All Channels

Range : +/-10 V Apply

SLEWRate

Enable

Rate: +/-64 V(mA) /s Apply

Safety Function

Enable Value : 5.000 Apply

Channel : 0

Value : -10.000 Output

-10 10

Set Safety

Channel Information

Name	Value	Modbus Address
Ch0	-10.000	
Ch1	-10.000	
Ch2	-10.000	
Ch3	-10.000	

Figure 4.18 Expand the Tree and Change the AMAX-5024 Range

4.2.4 Digital Input SubDevices

4.2.4.1 Obtain Digital Input Status

Through the DI tab, user can obtain the DI-related status and the Modbus address in the channel information (Figure 4.19).

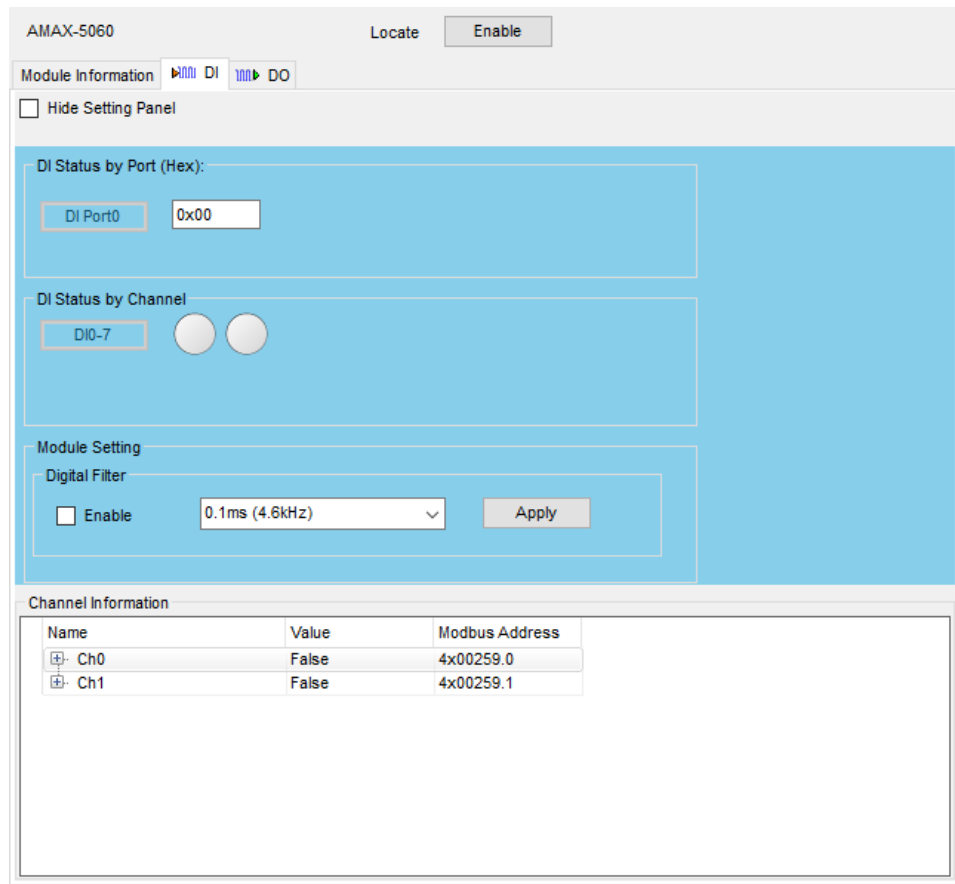

Figure 4.19 Digital Input Status

The tree in Channel Information can be expanded to show more detailed information (Figure 4.20).

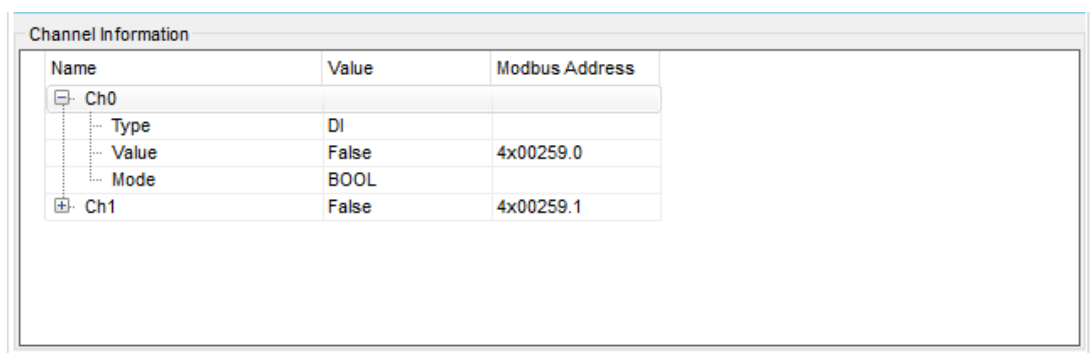

Figure 4.20 Digital Input Value and Modbus Address Information

4.2.4.2 Configure Digital Input

Channel information can be configured in different range. For example, if we want to Enable the channel 0 digital filter (Figure 4.21).

1. Expand the channel's tree and the selected Items will be shown on the blue area.
2. Enable the Digital Filter and Select the range you want. Next, click the Apply button.

The screenshot shows the configuration interface for the AMAX-5060 module. At the top, there are buttons for 'Locate' and 'Enable'. Below that, there are tabs for 'Module Information', 'DI', and 'DO'. A 'Hide Setting Panel' checkbox is present. The main area is divided into three sections: 'DI Status by Port (Hex):' with a 'DI Port0' dropdown and a '0x00' input field; 'DI Status by Channel' with a 'DIO-7' dropdown and two indicator lights; and 'Module Setting' which is highlighted with a red box. The 'Module Setting' section contains a 'Digital Filter' sub-section with an 'Enable' checkbox, a dropdown menu set to '0.1ms (4.6kHz)', and an 'Apply' button. At the bottom, there is a 'Channel Information' table.

Name	Value	Modbus Address
Ch0		
Type	DI	
Value	False	4x00259.0
Mode	BOOL	
Ch1	False	4x00259.1

Figure 4.21 Enable AMAX-5060 Digital Filter

4.2.5 Digital Output SubDevices

4.2.5.1 Obtain Digital Output Status

Through the DO tab, users can obtain the DO-related status and the Modbus address in the channel information (Figure 4.22).

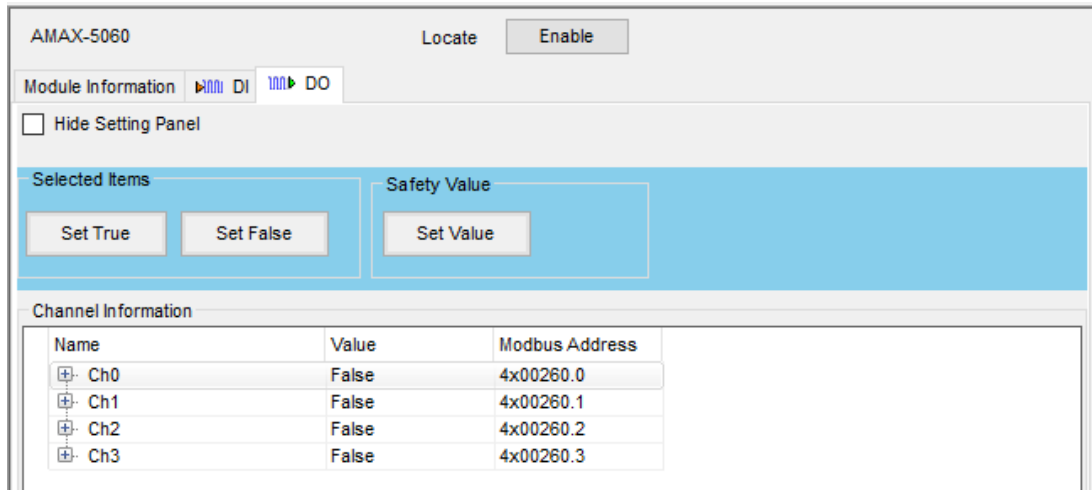

Figure 4.22 Digital Output Status

The tree in Channel Information can be expanded to show more detailed information (Figure 4.23).

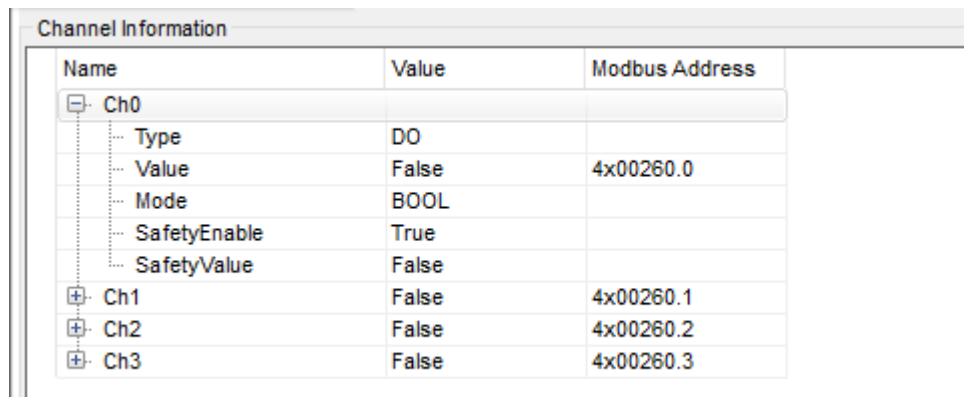

Figure 4.23 Digital Output Value and Modbus Address Information

4.2.5.2 Configure Digital Output

Channel information can be configured in different ranges. For example, we want to set the channel 0 output status for high level (Figure 4.24).

1. Expand the channel's tree and the selected Items will be shown in the blue area.
2. Click the Set True button.

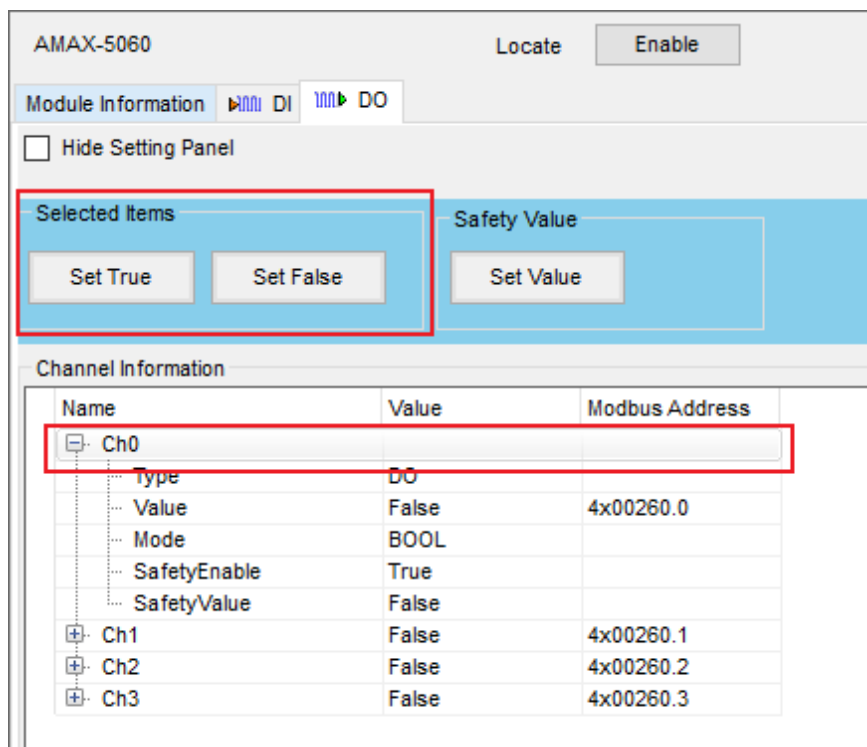

Figure 4.24 Change AMAX-5060 Digital Output Status

4.2.5.3 Configure Safety Value

Supported modules: AMAX-5060.

The safety function is SubDevice will output the safety value when modules disconnects from MainDevice. The DO safety value can be set when you click the Set Value button (Figure 4.25).

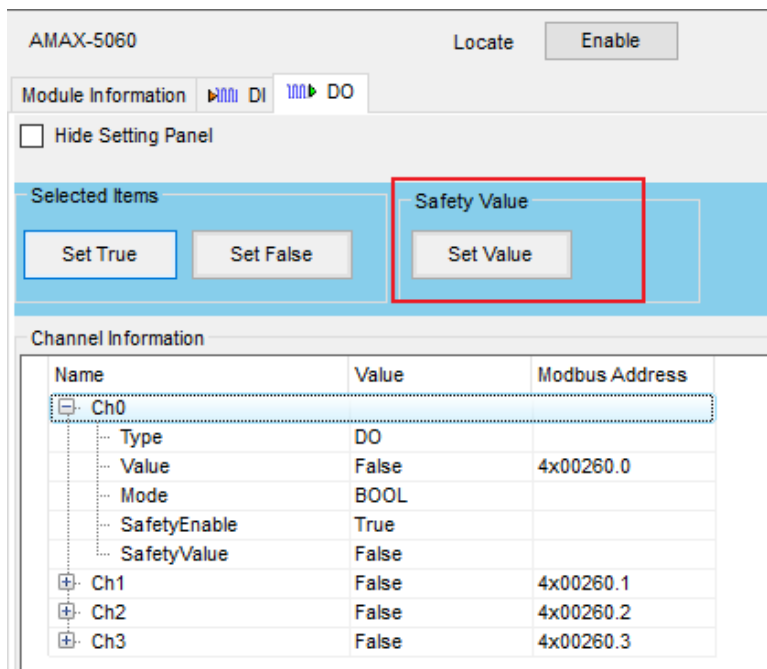

Figure 4.25 Configure AMAX-5060 Safety Value

After clicking the Set Value button, the Safety Setting page will be displayed, and individual channels can be checked for Enable/Safety State. Click the Apply button to save the changes (Figure 4.26).

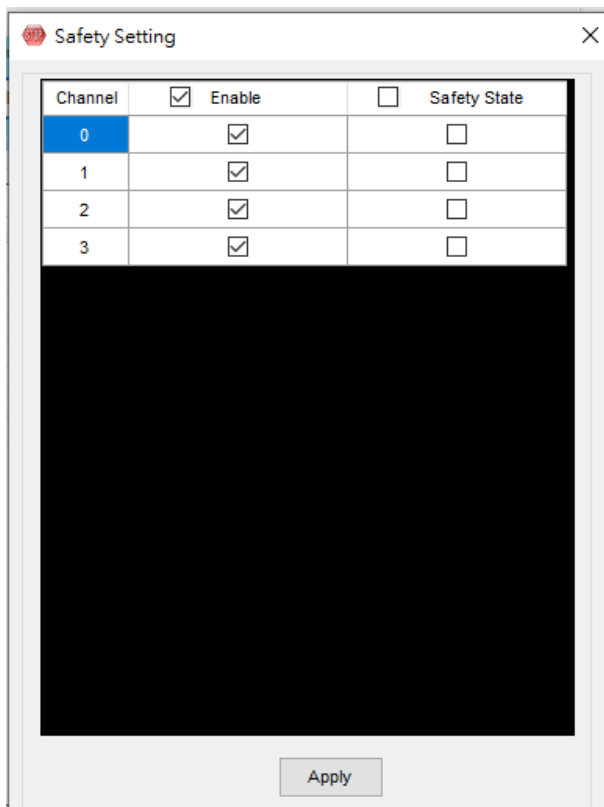

Figure 4.26 AMAX-5060 Safety Setting

4.2.6 Counter/Encoder SubDevices

4.2.6.1 Obtain Counter/Encoder State

Through the CNT tab, user can obtain the CNT-related status and the Modbus address in the channel information (Figure 4.27).

The screenshot shows the configuration interface for the AMAX-5080 device. At the top, there are 'Locate' and 'Enable' buttons. Below that, the 'Module Information' section shows 'CNT' selected. A 'Hide Setting Panel' checkbox is present. The main configuration area is divided into two columns. The left column contains settings for 'CNT Mode' (Encoder Mode), 'Set Counter Value' (0), 'Set Counter Boundary' (4294967295), and 'Digital filter' (Disable). The right column contains 'External Pin Setting' for 'Z Pin' and 'L Pin', both set to 'Latch_Counter' with 'Falling Edge' and 'Rising Edge' polarities respectively. Below these settings is a 'Channel Information' table with a red border:

Name	Value	Modbus Address
Ch0	0	4x00123
Ch1	0	4x00130

Figure 4.27 Counter and Encoder Status

The tree in Channel Information can be expanded to show more detailed information (Figure 4.28).

The screenshot shows the 'Channel Information' table expanded for 'Ch0'. The table has three columns: Name, Value, and Modbus Address. The 'Ch0' row is expanded to show a tree of sub-items:

Name	Value	Modbus Address
Ch0		
Type	CNT	
Counter_Value	0	4x00262
Set_Counter_Done	False	4x00261.0
Over_Flow	False	4x00261.3
Under_Flow	False	4x00261.4
Latch_Z_Valid	False	4x00261.1
Latch_External_Valid	False	4x00261.2
Status_of_Input_A	False	4x00261.8
Status_of_Input_B	False	4x00261.9
Status_of_Input_Z	False	4x00261.10
Status_of_external_La...	False	4x00261.11
Latch_Value	0	4x00264

Figure 4.28 Counter/Encoder and Modbus Address Information

4.2.6.2 Configure Counter/Encoder

Channel information can be configured in different mode for one channel or all channels.

The screenshot shows the configuration interface for the AMAX-5080 module. At the top, there are 'Locate' and 'Enable' buttons. Below is the 'Module Information' section with a 'CNT' icon and a 'Hide Setting Panel' checkbox. The main configuration area is titled 'Selected Items' and contains several settings:

- Apply to All Channels
- CNT Mode :** Encoder Mode (dropdown) [Apply]
- Set Counter Value (0~4294967295): 0 [Apply]
- Set Counter Boundary: Enable 4294967295 [Apply]
- Digital filter: Disable (dropdown) [Apply]

On the right side, there are 'External Pin Setting' options:

- Z Pin: Enable
- Function: Latch_Counter (dropdown)
- Polarity: Falling Edge (dropdown)
- L Pin: Enable
- Function: Latch_Counter (dropdown)
- Polarity: Rising Edge (dropdown)
- [Clear] [Apply]

At the bottom, the 'Channel Information' section contains a table:

Name	Value	Modbus Address
Ch0	0	4x00123
Ch1	0	4x00130

Figure 4.29 Change AMAX-5080 CNT Mode

External Pin Setting can be set to Latch Counter or Reset Counter. Check the Enable box to apply the function setting. The Latch Value can be found in the Channel Information if the Latch Counter Value is enabled. If you would like to discard the current Latch Counter Value, please click the Clear button (Figure 4.30).

AMAX-5080 Locate Enable

Module Information CNT

Hide Setting Panel

Selected Items

Apply to All Channels

CNT Mode : Encoder Mode Apply

Set Counter Value (0~4294967295): 0 Apply

Set Counter Boundary: Enable 4294967295 Apply

Digital filter: Disable Apply

External Pin Setting

Z Pin: Enable

Function: Latch_Counter v

Polarity: Falling Edge v

L Pin: Enable

Function: Latch_Counter v

Polarity: Rising Edge v

Clear Apply

Channel Information

Name	Value	Modbus Address
Status_of_external_La	False	4x00122.11
Latch_Value	0	4x00125
Frequency_value	0	4x00127
Set_Counter_Value	0	4x00137
Set_Counter	False	4x00136.0
Enable_Z_Pin	False	
Enable_L_Pin	False	
Z_Pin_Function	Latch_Counter	
L_Pin_Function	Latch_Counter	
Z_Latch_Polarity	Falling Edge	
L_Latch_Polarity	Rising Edge	
Mode	Encoder Mode	
Boundary_Value	4294967295	

Figure 4.30 Enable the Latch Counter

Chapter 5

Utility Management
Tool

5.1 Favorite Group Function

Favorite Group provides saving modules topology for the Utility in order to reduce the rescan time. Utility will load the Favorite Group's data (modules topology) when you restart the Utility. Right-click on the Favorite Group function node, and then click Add New Group in the menu (Figure 5.1).

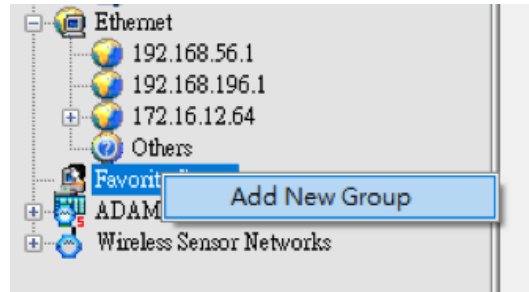

Figure 5.1 Add New Favorite Group

On the Group page, give the group a name and click Add (Figure 5.2).

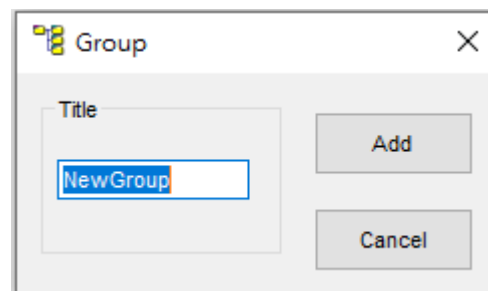

Figure 5.2 Create New Group

Right-click on the New Group (This name can be modified by user), and then click Add New Device in the menu (Figure 5.3).

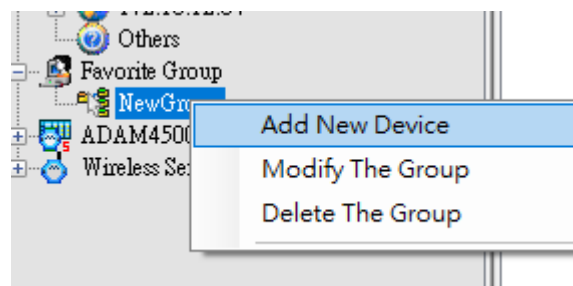

Figure 5.3 Add New Device for Favorite Group

Select the Ethernet Device tab, change the Module type to AMAX-5070 and key in the IP Address. Click Add for saving change (Figure 5.4).

The screenshot shows a 'New device' dialog box with the following fields and values:

Field	Value
Title	NewDevice
Serial Device	Ethernet Device
ModuleType	AMAX-5070
IP	192.168.56.0
Account Type	root
Password	
ConnectTimeout	2000
SendTimeout	2000
ReceiveTimeout	1000
ScanInterval	1000

The 'Add' button is highlighted with a red box.

Figure 5.4 Configure the Ethernet Device

The Ethernet device will appear below the NewGroup node after adding new ethernet device. User can click the Diagnosis Connection to detect whether the device is online or not (Figure 69). If all device can be detected online the Connect status will display GOOD (Figure 70), if not it will display CorrespondingFail (Figure 71).

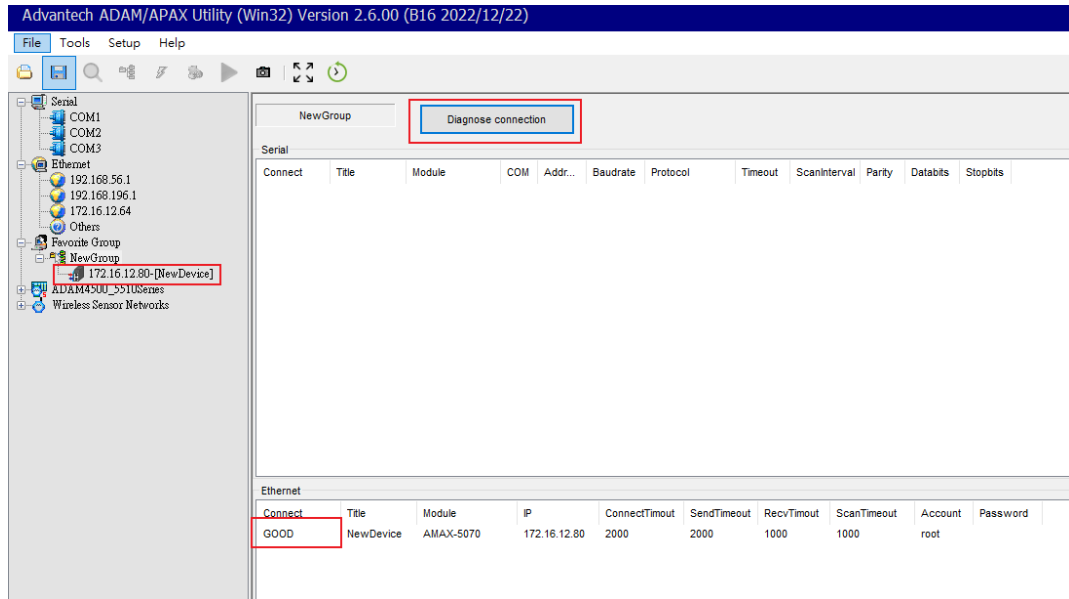

Figure 5.5 New Device Has Been Added Under Newgroup

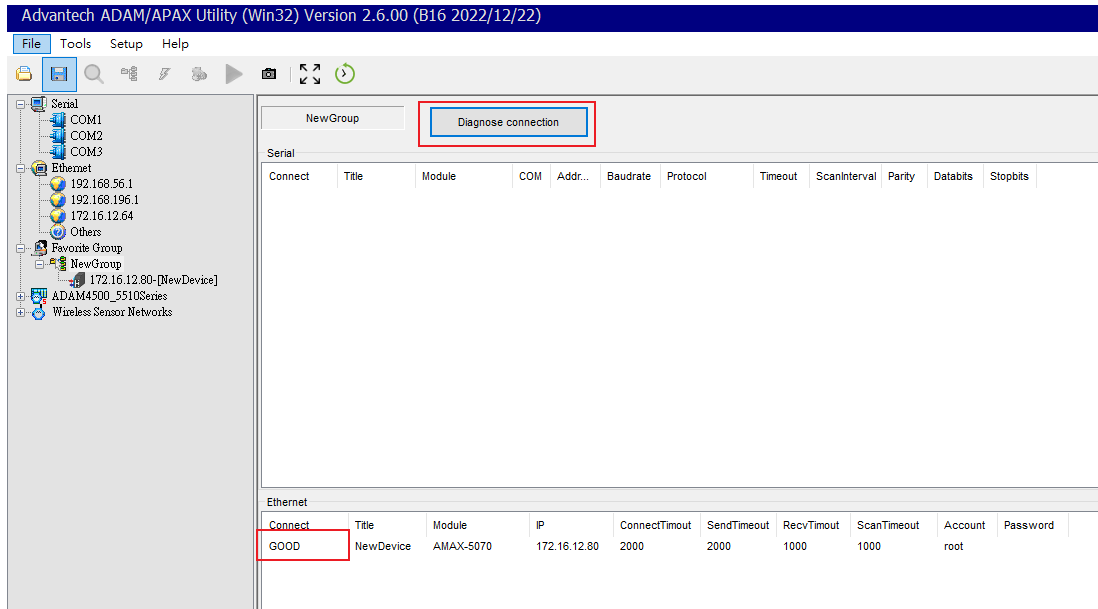

Figure 5.6 Connect Status is GOOD

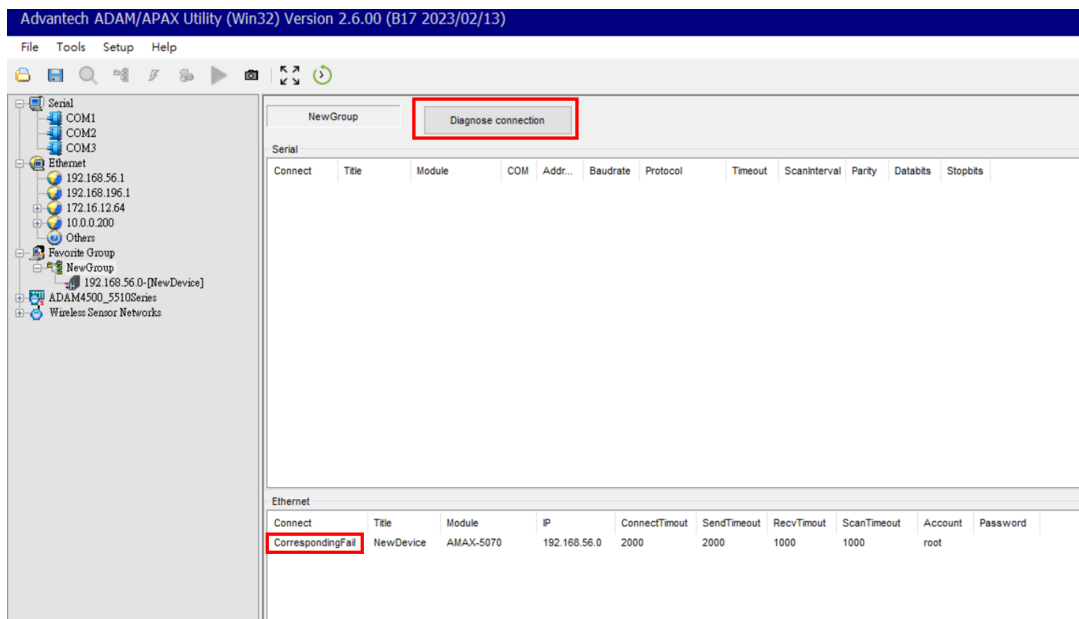

Figure 5.7 Connect Status is CorrespondingFail

User can configure the modules in Favorite Group (Figure 5.8).

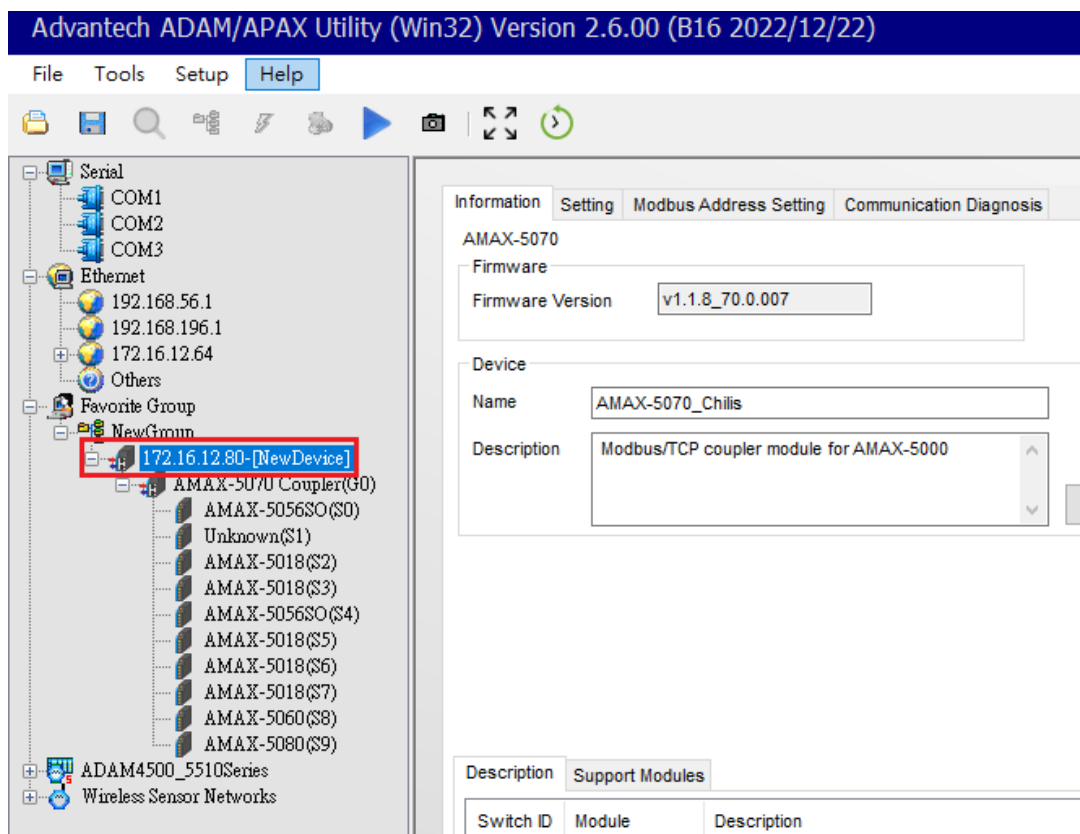

Figure 5.8 Configure the Modules in Favorite Group

5.2 Terminal for Command Testing Function

A terminal for Command Testing Function is supported for users to communicate with SubDevices via Modbus or ASCII command. After searching the Ethernet node, click on the Ethernet node and click the lightning icon (Figure 5.9).

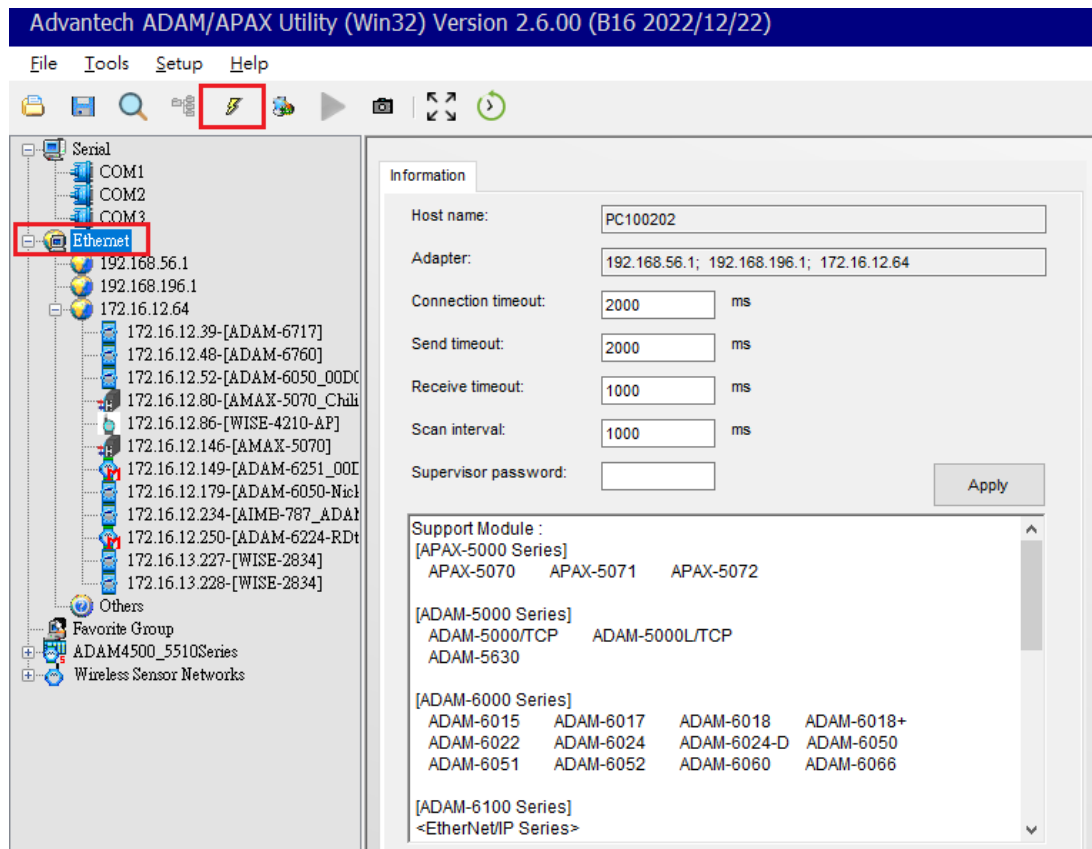

Figure 5.9 Entire the Terminal for Command Testing

Select the AMAX-5070's address and click the Connect button (Figure 5.10).

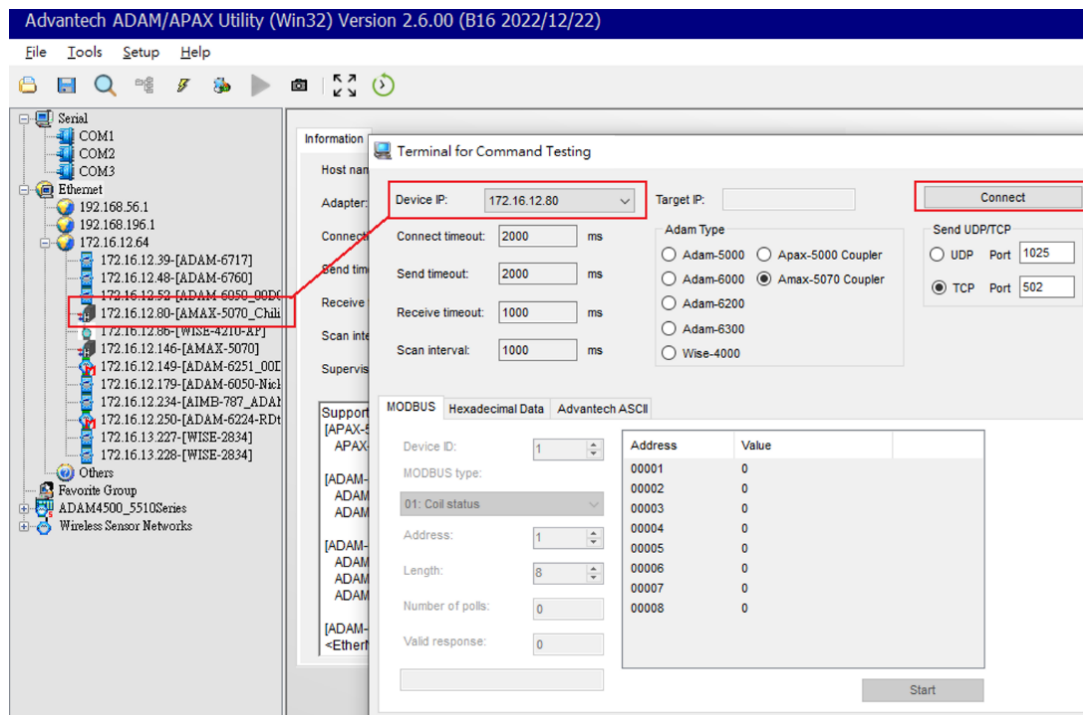

Figure 5.10 Connect to AMAX-5070 via Terminal for Command Testing

Select Modbus Type and click Start button to get Modbus information (Figure 5.11).

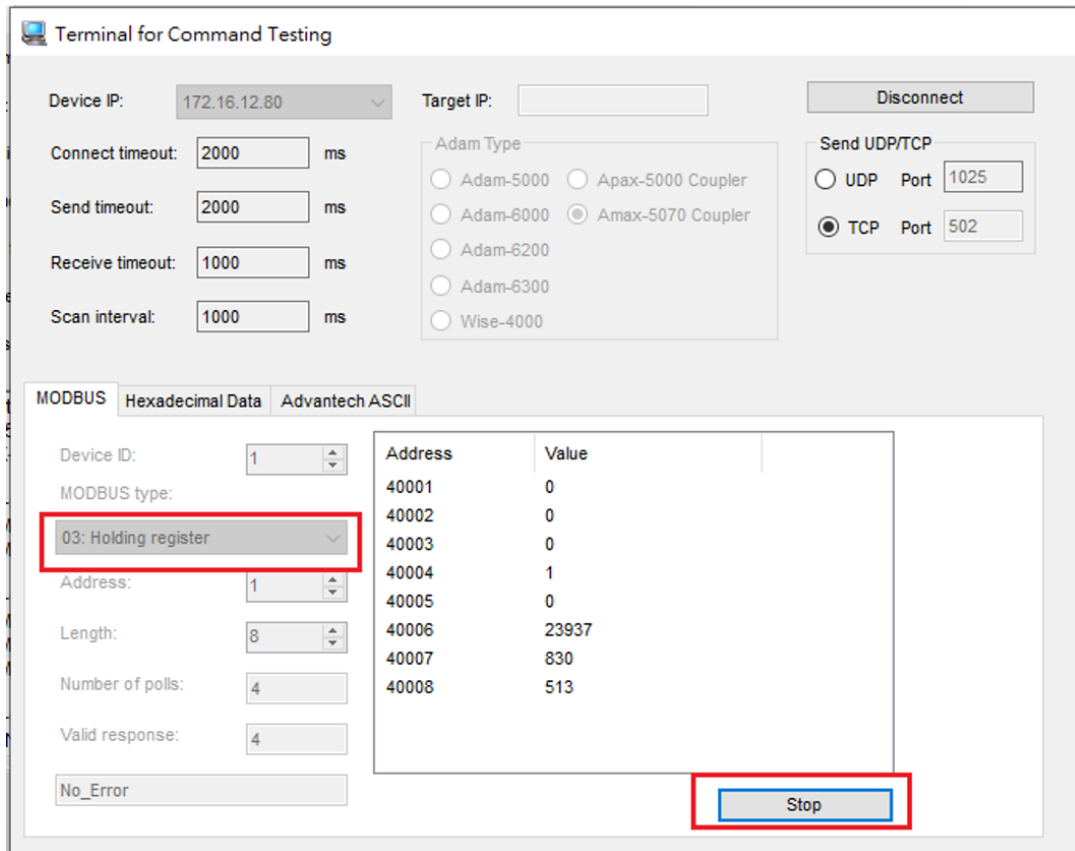

Figure 5.11 Modbus Information in Terminal for Command Testing

Click Disconnect and change from TCP to UDP in Send UDP/TCP. Click the Advantech ASCII tab and test the ASCII command (Figure 5.12).

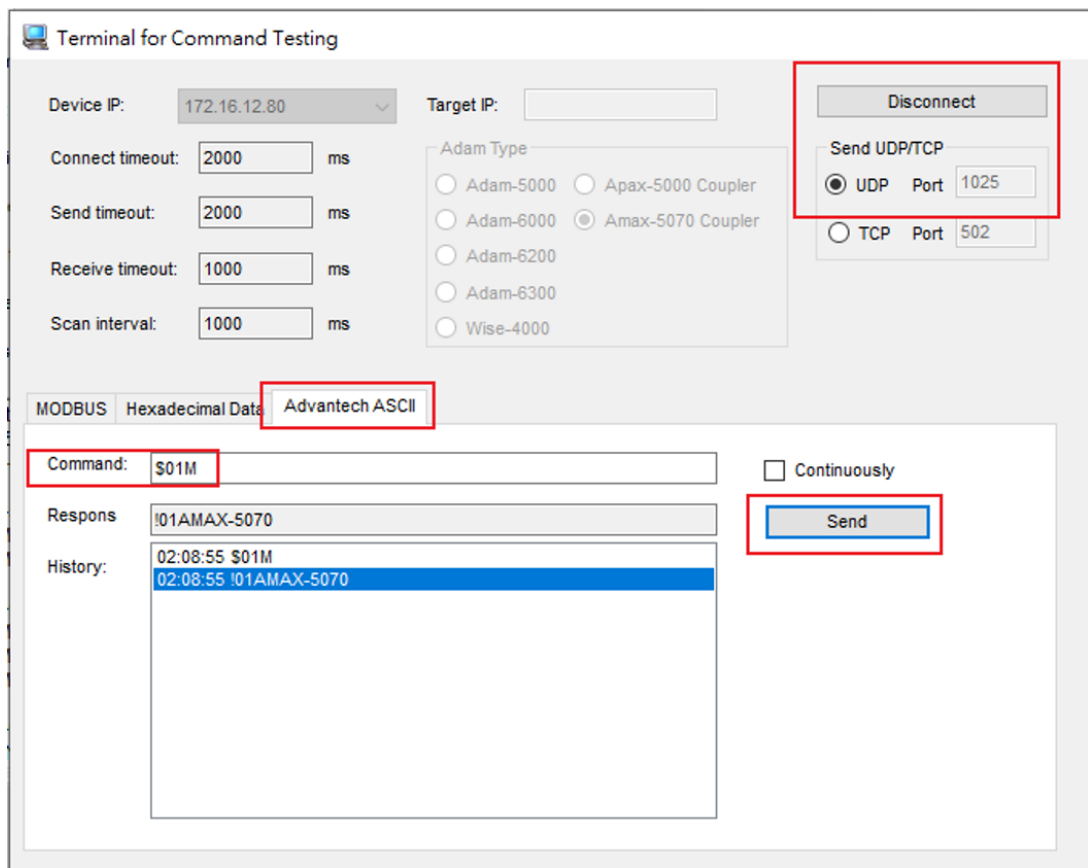

Figure 5.12 ASCII command in Terminal for Command Testing